

TEST REPORT

Applicant: Dragino Technology Co., Limited.

Address of Applicant: Room 202, BaoChengTai industrial park, No.8 CaiYun LongCheng Street, LongGang District, Shenzhen 518116, China

Manufacturer/Factory : Dragino Technology Co., Limited.

Address of Manufacturer/Factory : Room 202, BaoChengTai industrial park, No.8 CaiYun LongCheng Street, LongGang District, Shenzhen 518116, China

Equipment Under Test (EUT)

Product Name: LoRaWAN Sensor Node

Model No.: LSN50v2

Trade Mark: Dragino

FCC ID: ZHZLSN50V2

Applicable standards: FCC CFR Title 47 Part 15 Subpart C Section 15.247

Date of sample receipt: Oct. 12, 2020

Date of Test: Oct. 12 – Nov. 05, 2020

Date of report issued: Nov. 05, 2020

Test Result : PASS *

* In the configuration tested, the EUT complied with the standards specified above.

Authorized Signature:



Robinson Lo

Laboratory Manager

This results shown in this test report refer only to the sample(s) tested, this test report cannot be reproduced, except in full, without prior written permission of the company. The report would be invalid without specific stamp of test institute and the signatures of compiler and approver.

2 Version

Version No.	Date	Description
00	Nov. 05, 2020	Original

Prepared By:

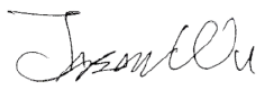

Date:

Nov. 05, 2020

Project Engineer

Check By:

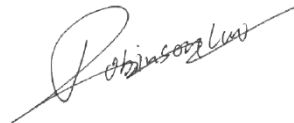

Date:

Nov. 05, 2020

Reviewer

3 Contents

	Page
1 COVER PAGE	1
2 VERSION.....	2
3 CONTENTS	3
4 TEST SUMMARY	5
5 GENERAL INFORMATION.....	6
5.1 GENERAL DESCRIPTION OF EUT	6
5.2 TEST MODE.....	8
5.3 DESCRIPTION OF SUPPORT UNITS	8
5.4 DEVIATION FROM STANDARDS.....	8
5.5 ABNORMALITIES FROM STANDARD CONDITIONS	8
5.6 TEST FACILITY	8
5.7 TEST LOCATION	8
6 TEST INSTRUMENTS LIST	9
7 TEST RESULTS AND MEASUREMENT DATA.....	11
7.1 ANTENNA REQUIREMENT	11
7.2 CONDUCTED EMISSIONS	12
8 TEST ITEMS FOR HYBRID.....	13
8.1 CONDUCTED PEAK OUTPUT POWER.....	13
8.2 20dB EMISSION BANDWIDTH	15
8.3 CARRIER FREQUENCIES SEPARATION	17
8.4 HOPPING CHANNEL NUMBER	19
8.5 DWELL TIME	20
8.6 PSEUDORANDOM FREQUENCY HOPPING SEQUENCE.....	22
8.7 BAND EDGE	23
8.7.1 <i>Conducted Emission Method</i>	23
8.7.2 <i>Radiated Emission Method</i>	25
8.8 SPURIOUS EMISSION.....	27
8.8.1 <i>Conducted Emission Method</i>	27
8.8.2 <i>Radiated Emission Method</i>	29
9 TEST ITEMS FOR DTS	37
9.1 CONDUCTED PEAK OUTPUT POWER.....	37
9.2 CHANNEL BANDWIDTH	39
9.3 POWER SPECTRAL DENSITY	41
9.4 BAND EDGES.....	43
9.4.1 <i>Conducted Emission Method</i>	43
9.4.2 <i>Radiated Emission Method</i>	44
9.5 SPURIOUS EMISSION.....	47
9.5.1 <i>Conducted Emission Method</i>	47
9.5.2 <i>Radiated Emission Method</i>	49

10	TEST SETUP PHOTO	57
11	EUT CONSTRUCTIONAL DETAILS.....	57

4 Test Summary

Test Item	Section in CFR 47	Result
Antenna Requirement	15.203/15.247 (c)	Pass
AC Power Line Conducted Emission	15.207	N/A
Conducted Peak Output Power	15.247 (b)(1)	Pass
20dB Occupied Bandwidth	15.247 (a)(1)	Pass
Carrier Frequencies Separation	15.247 (a)(1)	Pass
Hopping Channel Number	15.247 (a)(1)	Pass
Dwell Time	15.247 (a)(1)	Pass
Pseudorandom Frequency Hopping Sequence	15.247(b)(4)	Pass
Radiated Emission	15.205/15.209	Pass
Band Edge	15.247(d)	Pass
Power Spectral Density	15.247 (e)	Pass

Remarks:

1. *Pass: The EUT complies with the essential requirements in the standard.*
2. *Test according to ANSI C63.10:2013*

Measurement Uncertainty

Test Item	Frequency Range	Measurement Uncertainty	Notes
Radiated Emission	30MHz-200MHz	3.8039dB	(1)
Radiated Emission	200MHz-1GHz	3.9679dB	(1)
Radiated Emission	1GHz-18GHz	4.29dB	(1)
Radiated Emission	18GHz-40GHz	3.30dB	(1)
AC Power Line Conducted Emission	0.15MHz ~ 30MHz	3.44dB	(1)

Note (1): The measurement uncertainty is for coverage factor of k=2 and a level of confidence of 95%.

5 General Information

5.1 General Description of EUT

Product Name:	LoRaWAN Sensor Node
Model No.:	LSN50v2
Test sample(s) ID:	GTSxxx
Sample(s) Status:	Engineer sample
Serial No.:	N/A
Hardware Version:	N/A
Software Version:	N/A
Operation Frequency:	902MHz~928MHz
Channel numbers:	64 for 125KHz bandwidth 8 for 500KHz bandwidth
Channel separation:	200KHz for 125KHz bandwidth 1.6MHz for 500KHz bandwidth
Modulation type:	FSK
Antenna Type:	Integral antenna
Antenna gain:	2dBi
Power supply:	DC 3.6V from Battery

125KHz for FHSS:

Operation Frequency each of channel							
Channel	Frequency (MHz)	Channel	Frequency (MHz)	Channel	Frequency (MHz)	Channel	Frequency (MHz)
1	902.3	17	905.5	33	908.7	49	911.9
2	902.5	18	905.7	34	908.9	50	912.1
3	902.7	19	905.9	35	909.1	51	912.3
4	902.9	20	906.1	36	909.3	52	912.5
.
.
.
13	904.7	29	907.9	45	911.1	61	914.3
14	904.9	30	908.1	46	911.3	62	914.5
15	905.1	31	908.3	47	911.5	63	914.7
16	905.3	32	908.5	48	911.7	64	914.9

500KHz for DTS:

Operation Frequency each of channel							
Channel	Frequency (MHz)	Channel	Frequency (MHz)	Channel	Frequency (MHz)	Channel	Frequency (MHz)
1	903.0	3	906.2	5	909.4	7	912.6
2	904.6	4	907.8	6	911.0	8	914.2

Note:

In section 15.31(m), regards to the operating frequency range over 10 MHz, the Lowest frequency, the middle frequency, and the highest frequency of channel were selected to perform the test, and the selected channel see below:

Channel	Frequency(125KHz)	Frequency(500KHz)
The lowest channel	902.30MHz	903.00MHz
The middle channel	908.50MHz	909.40MHz
The Highest channel	914.90MHz	914.20MHz

5.2 Test mode

Transmitting mode	Keep the EUT in continuously transmitting mode.
<i>Remark: full battery is used</i>	

5.3 Description of Support Units

None.

5.4 Deviation from Standards

None.

5.5 Abnormalities from Standard Conditions

None.

5.6 Test Facility

<p>The test facility is recognized, certified, or accredited by the following organizations:</p> <ul style="list-style-type: none">● FCC —Registration No.: 381383 Global United Technology Services Co., Ltd., Shenzhen EMC Laboratory has been registered and fully described in a report filed with the (FCC) Federal Communications Commission. The acceptance letter from the FCC is maintained in files. Registration 381383.● IC —Registration No.: 9079A The 3m Semi-anechoic chamber of Global United Technology Services Co., Ltd. has been registered by Certification and Engineering Bureau of Industry Canada for radio equipment testing with Registration No.: 9079A● NVLAP (LAB CODE:600179-0) Global United Technology Services Co., Ltd., is accredited by the National Voluntary Laboratory Accreditation Program (NVLAP). LAB CODE:600179-0

5.7 Test Location

All tests were performed at:
Global United Technology Services Co., Ltd. Address: No. 123-128, Tower A, Jinyuan Business Building, No.2, Laodong Industrial Zone, Xixiang Road, Baoan District, Shenzhen, Guangdong, China 518102 Tel: 0755-27798480 Fax: 0755-27798960

6 Test Instruments list

Radiated Emission:						
Item	Test Equipment	Manufacturer	Model No.	Inventory No.	Cal.Date (mm-dd-yy)	Cal.Due date (mm-dd-yy)
1	3m Semi- Anechoic Chamber	ZhongYu Electron	9.2(L)*6.2(W)* 6.4(H)	GTS250	July. 02 2020	July. 01 2025
2	Control Room	ZhongYu Electron	6.2(L)*2.5(W)* 2.4(H)	GTS251	N/A	N/A
3	EMI Test Receiver	Rohde & Schwarz	ESU26	GTS203	June. 25 2020	June. 24 2021
4	BiConiLog Antenna	SCHWARZBECK MESS-ELEKTRONIK	VULB9163	GTS214	June. 25 2020	June. 24 2021
5	Double -ridged waveguide horn	SCHWARZBECK MESS-ELEKTRONIK	BBHA 9120 D	GTS208	June. 25 2020	June. 24 2021
6	Horn Antenna	ETS-LINDGREN	3160	GTS217	June. 25 2020	June. 24 2021
7	EMI Test Software	AUDIX	E3	N/A	N/A	N/A
8	Coaxial Cable	GTS	N/A	GTS213	June. 25 2020	June. 24 2021
9	Coaxial Cable	GTS	N/A	GTS211	June. 25 2020	June. 24 2021
10	Coaxial cable	GTS	N/A	GTS210	June. 25 2020	June. 24 2021
11	Coaxial Cable	GTS	N/A	GTS212	June. 25 2020	June. 24 2021
12	Amplifier(100kHz-3GHz)	HP	8347A	GTS204	June. 25 2020	June. 24 2021
13	Amplifier(2GHz-20GHz)	HP	84722A	GTS206	June. 25 2020	June. 24 2021
14	Amplifier (18-26GHz)	Rohde & Schwarz	AFS33-18002 650-30-8P-44	GTS218	June. 25 2020	June. 24 2021
15	Band filter	Amindeon	82346	GTS219	June. 25 2020	June. 24 2021
16	Power Meter	Anritsu	ML2495A	GTS540	June. 25 2020	June. 24 2021
17	Power Sensor	Anritsu	MA2411B	GTS541	June. 25 2020	June. 24 2021
18	Wideband Radio Communication Tester	Rohde & Schwarz	CMW500	GTS575	June. 25 2020	June. 24 2021
19	Splitter	Agilent	11636B	GTS237	June. 25 2020	June. 24 2021
20	Loop Antenna	ZHINAN	ZN30900A	GTS534	June. 25 2020	June. 24 2021
21	Breitband hornantenne	SCHWARZBECK	BBHA 9170	GTS579	Oct. 18 2020	Oct. 17 2021
22	Amplifier	TDK	PA-02-02	GTS574	Oct. 18 2020	Oct. 17 2021
23	Amplifier	TDK	PA-02-03	GTS576	Oct. 18 2020	Oct. 17 2021
24	PSA Series Spectrum Analyzer	Rohde & Schwarz	FSP	GTS578	June. 25 2020	June. 24 2021

RF Conducted Test:						
Item	Test Equipment	Manufacturer	Model No.	Serial No.	Cal.Date (mm-dd-yy)	Cal.Due date (mm-dd-yy)
1	MXA Signal Analyzer	Agilent	N9020A	GTS566	June. 25 2020	June. 24 2021
2	EMI Test Receiver	R&S	ESCI 7	GTS552	June. 25 2020	June. 24 2021
3	Spectrum Analyzer	Agilent	E4440A	GTS533	June. 25 2020	June. 24 2021
4	MXG vector Signal Generator	Agilent	N5182A	GTS567	June. 25 2020	June. 24 2021
5	ESG Analog Signal Generator	Agilent	E4428C	GTS568	June. 25 2020	June. 24 2021
6	USB RF Power Sensor	DARE	RPR3006W	GTS569	June. 25 2020	June. 24 2021
7	RF Switch Box	Shongyi	RFSW3003328	GTS571	June. 25 2020	June. 24 2021
8	Programmable Constant Temp & Humi Test Chamber	WEWON	WHTH-150L-40-880	GTS572	June. 25 2020	June. 24 2021

General used equipment:						
Item	Test Equipment	Manufacturer	Model No.	Inventory No.	Cal.Date (mm-dd-yy)	Cal.Due date (mm-dd-yy)
1	Humidity/ Temperature Indicator	KTJ	TA328	GTS243	June. 25 2020	June. 24 2021
2	Barometer	ChangChun	DYM3	GTS255	June. 25 2020	June. 24 2021

7 Test results and Measurement Data

7.1 Antenna requirement

Standard requirement:	FCC Part15 C Section 15.203 /247(c)
<p>15.203 requirement:</p> <p>An intentional radiator shall be designed to ensure that no antenna other than that furnished by the responsible party shall be used with the device. The use of a permanently attached antenna or of an antenna that uses a unique coupling to the intentional radiator, the manufacturer may design the unit so that a broken antenna can be replaced by the user, but the use of a standard antenna jack or electrical connector is prohibited.</p>	
<p>15.247(c) (1)(i) requirement:</p> <p>(i) Systems operating in the 2400-2483.5 MHz band that is used exclusively for fixed. Point-to-point operations may employ transmitting antennas with directional gain greater than 6dBi provided the maximum conducted output power of the intentional radiator is reduced by 1 dB for every 3 dB that the directional gain of the antenna exceeds 6dBi.</p>	
<p>E.U.T Antenna:</p>	
<p><i>The antenna is integral antenna, the best case gain of the is 2dBi, reference to the appendix II for details.</i></p>	

7.2 Conducted Emissions

Test Requirement:	FCC Part15 C Section 15.207					
Test Method:	ANSI C63.10:2013					
Test Frequency Range:	150KHz to 30MHz					
Class / Severity:	Class B					
Receiver setup:	RBW=9KHz, VBW=30KHz, Sweep time=auto					
Limit:	Frequency range (MHz)		Limit (dBuV)			
			Quasi-peak		Average	
	0.15-0.5		66 to 56*		56 to 46*	
	0.5-5		56		46	
5-30		60		50		
* Decreases with the logarithm of the frequency.						
Test setup:						
	<p><i>Remark</i> E.U.T: Equipment Under Test LISN: Line Impedance Stabilization Network Test table height=0.8m</p>					
Test procedure:	<ol style="list-style-type: none"> 1. The E.U.T and simulators are connected to the main power through a line impedance stabilization network (L.I.S.N.). This provides a 50ohm/50uH coupling impedance for the measuring equipment. 2. The peripheral devices are also connected to the main power through a LISN that provides a 50ohm/50uH coupling impedance with 50ohm termination. (Please refer to the block diagram of the test setup and photographs). 3. Both sides of A.C. line are checked for maximum conducted interference. In order to find the maximum emission, the relative positions of equipment and all of the interface cables must be changed according to ANSI C63.10:2013 on conducted measurement. 					
Test Instruments:	Refer to section 6.0 for details					
Test mode:	Refer to section 5.2 for details					
Test environment:	Temp.:	25 °C	Humid.:	52%	Press.:	1012mbar
Test voltage:	AC 120V, 60Hz					
Test results:	N/A					

8 Test Items for Hybrid

8.1 Conducted Peak Output Power

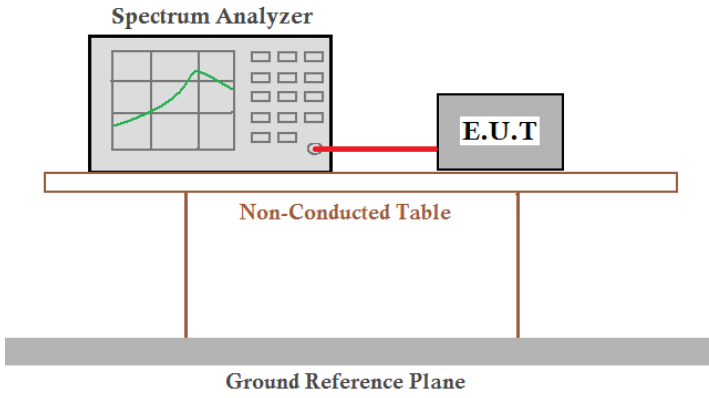
Test Requirement:	FCC Part15 C Section 15.247 (b)(3)
Test Method:	ANSI C63.10:2013
Limit:	30dBm
Test setup:	 <p>The diagram illustrates the test setup. A Spectrum Analyzer is connected to an E.U.T. (Equipment Under Test) via a red cable. Both are placed on a Non-Conducted Table, which is supported by a Ground Reference Plane.</p>
Test Instruments:	Refer to section 6.0 for details
Test mode:	Refer to section 5.2 for details
Test results:	Pass

Measurement Data

Mode	Test channel	Peak Output Power (dBm)	Limit (dBm)	Result
125KHz Bandwidth	Lowest	17.431	30.00	Pass
	Middle	17.461		
	Highest	17.487		

Test plot as follows:

Test mode:	125KHz Bandwidth
------------	------------------

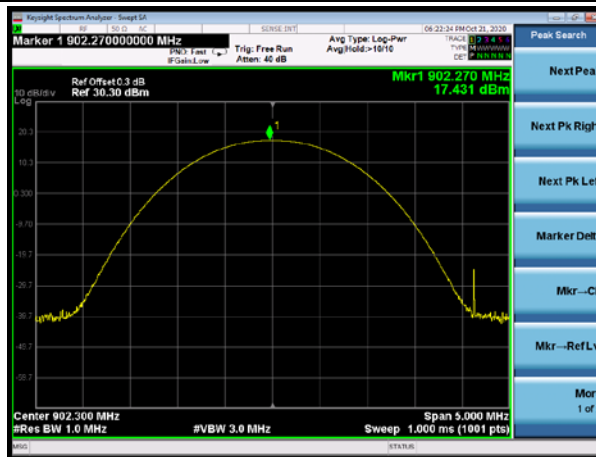

Lowest channel

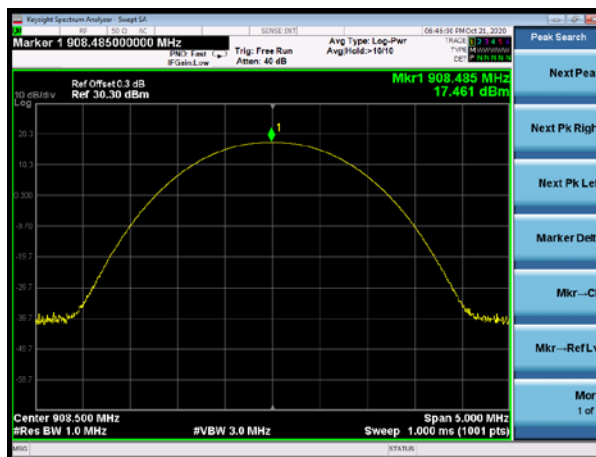

Middle channel

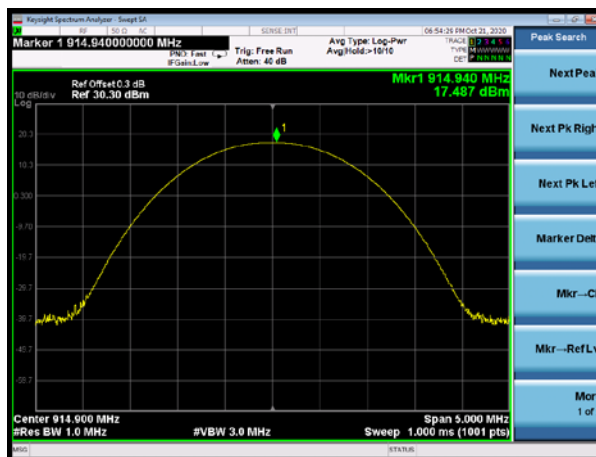

Highest channel

8.2 20dB Emission Bandwidth

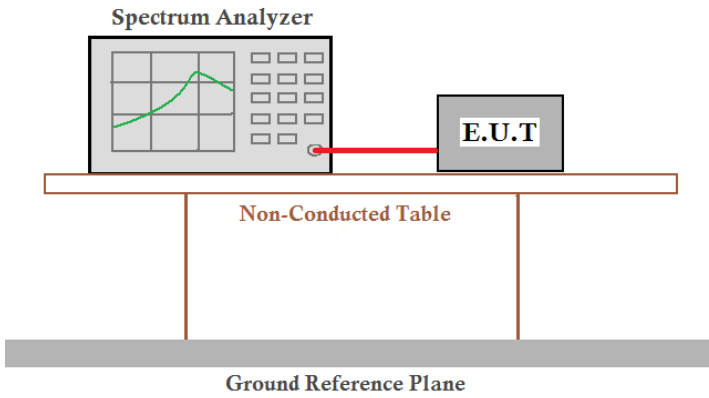
Test Requirement:	FCC Part15 C Section 15.247 (a)(1)
Test Method:	ANSI C63.10:2013
Limit:	Less than 500KHz
Test setup:	 <p>The diagram illustrates the test setup. A Spectrum Analyzer is connected to an E.U.T. (Equipment Under Test) via a red cable. Both are placed on a Non-Conducted Table, which is supported by a Ground Reference Plane.</p>
Test Instruments:	Refer to section 6.0 for details
Test mode:	Refer to section 5.2 for details
Test results:	Pass

Measurement Data

Mode	Test channel	20dB Emission Bandwidth (KHz)	Result
125KHz Bandwidth	Lowest	136.7	Pass
	Middle	138.4	
	Highest	136.6	

Test plot as follows:

Test mode:	125KHz Bandwidth
------------	------------------

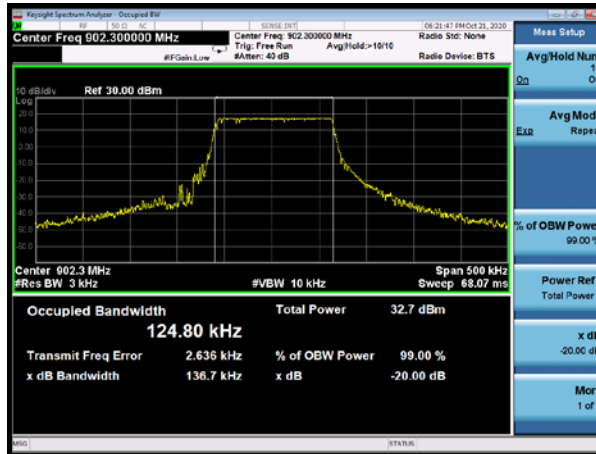

Lowest channel

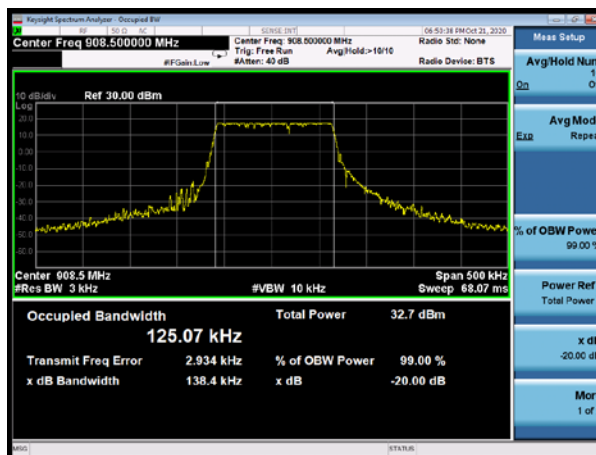

Middle channel



Highest channel

8.3 Carrier Frequencies Separation

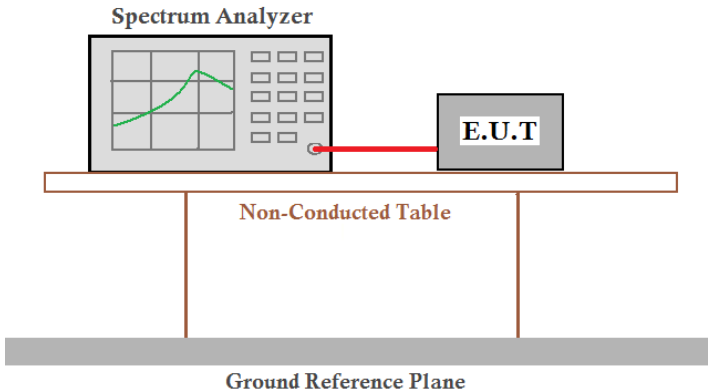
Test Requirement:	FCC Part15 C Section 15.247 (a)(1)
Test Method:	ANSI C63.10:2013
Receiver setup:	RBW=100KHz, VBW=300KHz, detector=Peak
Limit:	Frequency hopping systems shall have hopping channel carrier frequencies separated by a minimum of 25 kHz or the 20 dB bandwidth of the hopping channel, whichever is greater
Test setup:	 <p>The diagram shows a Spectrum Analyzer and an E.U.T. (Equipment Under Test) connected by a red cable. They are positioned on a table labeled 'Non-Conducted Table'. Below the table is a 'Ground Reference Plane'.</p>
Test Instruments:	Refer to section 6.0 for details
Test mode:	Refer to section 5.2 for details
Test results:	Pass

Measurement Data

Mode	Test channel	Carrier Frequencies Separation (kHz)	Limit (kHz)	Result
125KHz Bandwidth	Lowest	200.40	138.4	Pass
	Middle	200.40	138.4	Pass
	Highest	201.00	138.4	Pass

Note: According to section 8.2

Mode	20dB bandwidth (kHz) (worse case)	Limit (kHz) (Carrier Frequencies Separation)
125KHz Bandwidth	138.4	138.4

Test plot as follows:

Modulation mode:	125KHz Bandwidth
------------------	------------------



Lowest channel

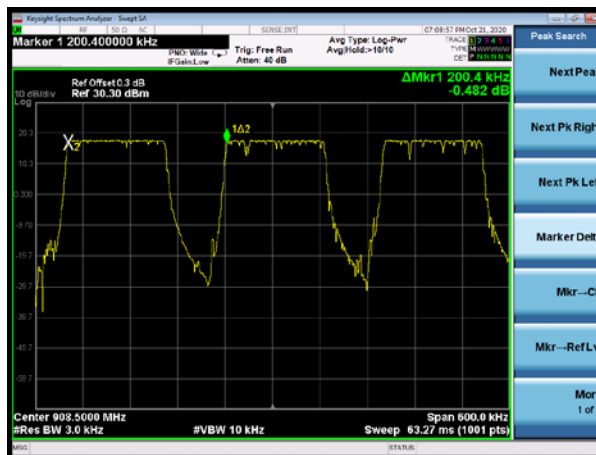

Middle channel

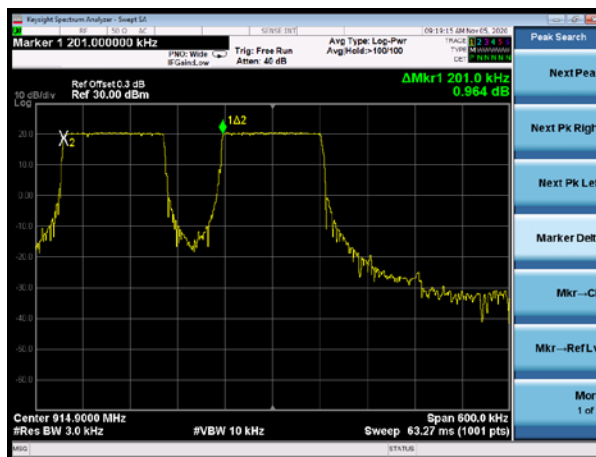

Highest channel

8.4 Hopping Channel Number

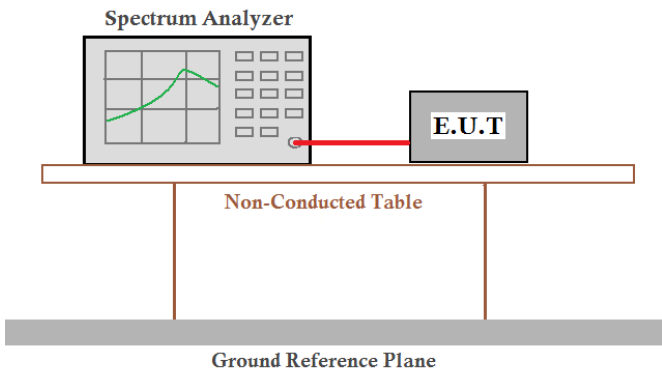
Test Requirement:	FCC Part15 C Section 15.247 (a)(1)
Test Method:	ANSI C63.10:2013
Receiver setup:	RBW=100kHz, VBW=300kHz, Frequency range=2400MHz-2483.5MHz, Detector=Peak
Limit:	If the 20 dB bandwidth of the hopping channel is less than 250 kHz, the system shall use at least 50 hopping frequencies. If the 20 dB bandwidth of the hopping channel is 250 kHz or greater, the system shall use at least 25 hopping frequencies
Test setup:	 <p>The diagram illustrates the test setup. A Spectrum Analyzer is connected to an E.U.T. (Equipment Under Test) via a red cable. Both are placed on a Non-Conducted Table. Below the table is a Ground Reference Plane.</p>
Test Instruments:	Refer to section 6.0 for details
Test mode:	Refer to section 5.2 for details
Test results:	Pass

Measurement Data:

Mode	Hopping channel numbers	Limit	Result
125KHz Bandwidth	64	50	Pass

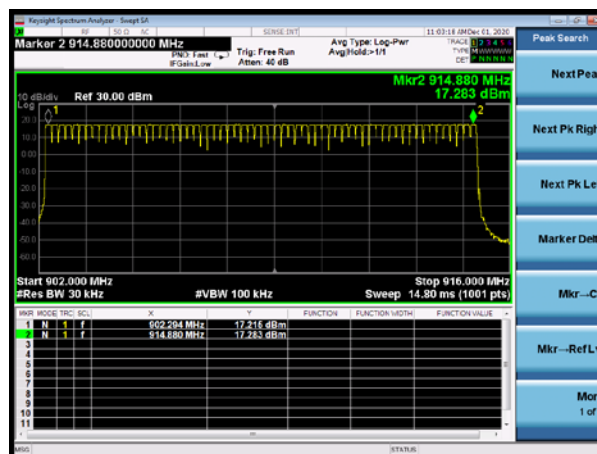

8.5 Dwell Time

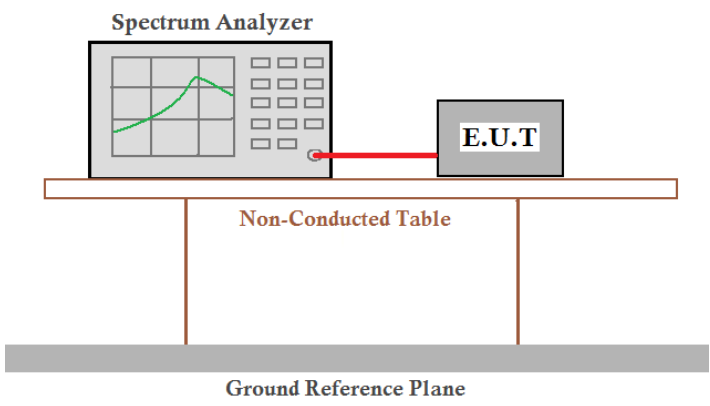
Test Requirement:	FCC Part15 C Section 15.247 (a)(1)
Test Method:	ANSI C63.10:2013
Receiver setup:	RBW=10kHz, VBW=30KHz, Span=0Hz, Detector=Peak
Limit:	0.4 Second
Test setup:	 <p>The diagram illustrates the test setup. A Spectrum Analyzer is connected to an E.U.T. (Equipment Under Test) via a red cable. Both are placed on a Non-Conducted Table, which is supported by a Ground Reference Plane.</p>
Test Instruments:	Refer to section 6.0 for details
Test mode:	Refer to section 5.2 for details
Test results:	Pass

Measurement Data

Mode	Ton(ms)	Dwell time(ms)	Limit(ms)	Result
125KHz Bandwidth	372.00	372.00	400	Pass

Test plot as follows:

Test Mode:	125KHz Bandwidth
------------	------------------



Ton

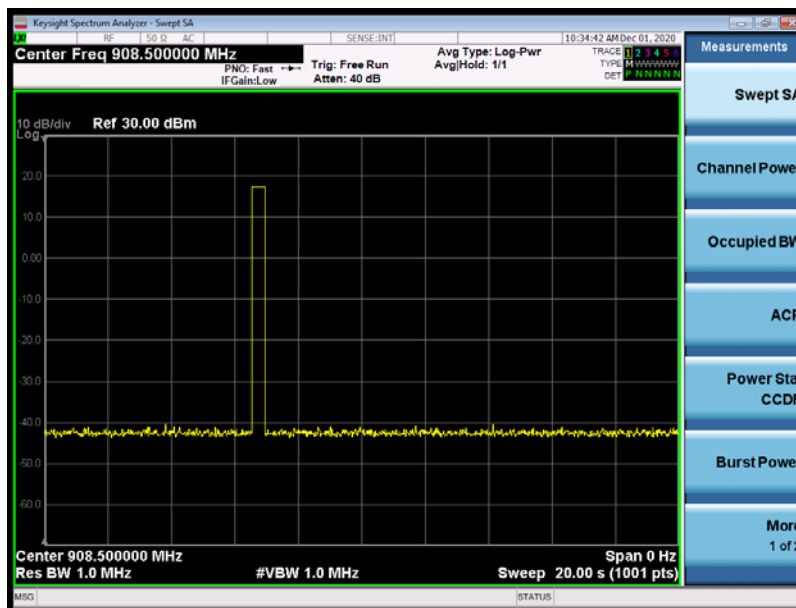

Tperiod

8.6 Pseudorandom Frequency Hopping Sequence

Test Requirement:	FCC Part15 C Section 15.247 (a)(1)/g/h requirement:
<p><i>a(1): Frequency hopping systems shall have hopping channel carrier frequencies separated by a minimum of 25 kHz or the 20 dB bandwidth of the hopping channel, whichever is greater.</i></p> <p><i>Alternatively. Frequency hopping systems operating in the 2400-2483.5 MHz band may have hopping channel carrier frequencies that are separated by 25 kHz or two-thirds of the 20 dB bandwidth of the hopping channel, whichever is greater, provided the systems operate with an output power no greater than 125 mW. The system shall hop to channel frequencies that are selected at the system hopping rate from a Pseudorandom ordered list of hopping frequencies. Each frequency must be used equally on the average by each transmitter. The system receivers shall have input bandwidths that match the hopping channel bandwidths of their corresponding transmitters and shall shift frequencies in synchronization with the transmitted signals.</i></p> <p><i>(g) Frequency hopping spread spectrum systems are not required to employ all available hopping channels during each transmission. However, the system, consisting of both the transmitter and the receiver, must be designed to comply with all of the regulations in this section should the transmitter be presented with a continuous data (or information) stream. In addition, a system employing short transmission bursts must comply with the definition of a frequency hopping system and must distribute its transmissions over the minimum number of hopping channels specified in this section.</i></p> <p><i>(h) The incorporation of intelligence within a frequency hopping spread spectrum system that permits the system to recognize other users within the spectrum band so that it individually and independently chooses and adapts its hopsets to avoid hopping on occupied channels is permitted. The coordination of frequency hopping systems in any other manner for the express purpose of avoiding the simultaneous occupancy of individual hopping frequencies by multiple transmitters is not permitted.</i></p>	
EUT Pseudorandom Frequency Hopping Sequence	
<p><i>The pseudorandom sequence may be generated in a nine-stage shift register whose 5th and 9th stage outputs are added in a modulo-two addition stage. And the result is fed back to the input of the first stage. The sequence begins with the first ONE of 9 consecutive ONEs; i.e. the shift register is initialized with nine ones.</i></p> <ul style="list-style-type: none"> • Number of shift register stages: 9 • Length of pseudo-random sequence: $2^9 - 1 = 511$ bits • Longest sequence of zeros: 8 (non-inverted signal) <div data-bbox="236 1261 1289 1413" style="text-align: center;"> </div> <p style="text-align: center;"><i>Linear Feedback Shift Register for Generation of the PRBS sequence</i></p> <p><i>An example of Pseudorandom Frequency Hopping Sequence as follow:</i></p> <div data-bbox="248 1514 1241 1659" style="text-align: center;"> </div> <p><i>Each frequency used equally on the average by each transmitter.</i></p> <p><i>The system receivers have input bandwidths that match the hopping channel bandwidths of their corresponding transmitters and shift frequencies in synchronization with the transmitted signals.</i></p> <p><i>it permits the system to recognize other users within the spectrum band so that it individually and independently chooses and adapts its hopsets to avoid hopping on occupied channels is permitted.</i></p>	

8.7 Band Edge

8.7.1 Conducted Emission Method

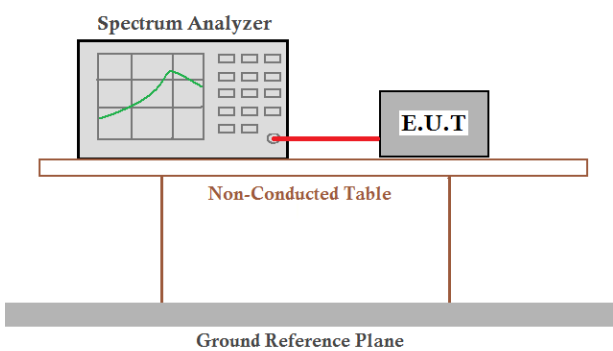
Test Requirement:	FCC Part15 C Section 15.247 (d)
Test Method:	ANSI C63.10:2013
Receiver setup:	RBW=100kHz, VBW=300kHz, Detector=Peak
Limit:	In any 100 kHz bandwidth outside the frequency band in which the spread spectrum intentional radiator is operating, the radio frequency power that is produced by the intentional radiator shall be at least 20 dB below that in the 100 kHz bandwidth within the band that contains the highest level of the desired power, based on either an RF conducted or a radiated measurement.
Test setup:	 <p>The diagram illustrates the test setup. A Spectrum Analyzer is connected to an E.U.T. (Equipment Under Test) via a red cable. Both are placed on a Non-Conducted Table, which is supported by two legs. Below the table is a Ground Reference Plane.</p>
Test Instruments:	Refer to section 6.0 for details
Test mode:	Refer to section 5.2 for details
Test results:	Pass

Test plot as follows:
125KHz Bandwidth:

Test channel: Lowest channel

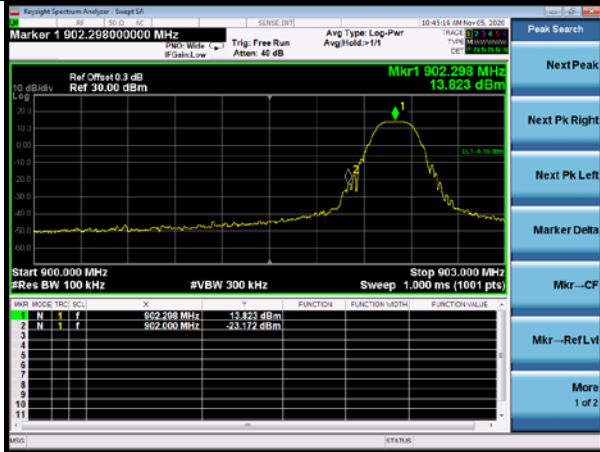

No-hopping mode

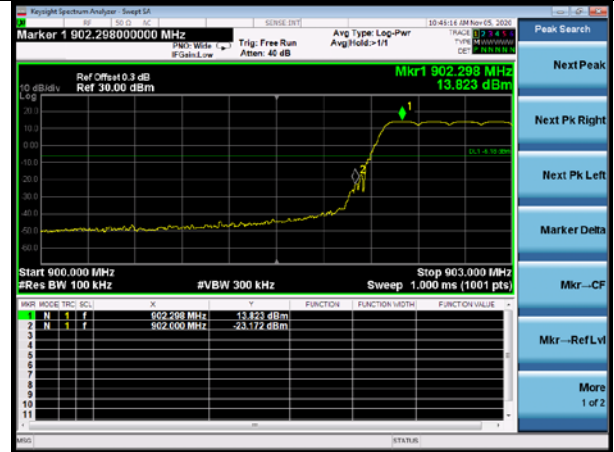

Hopping mode

Test channel: Highest channel

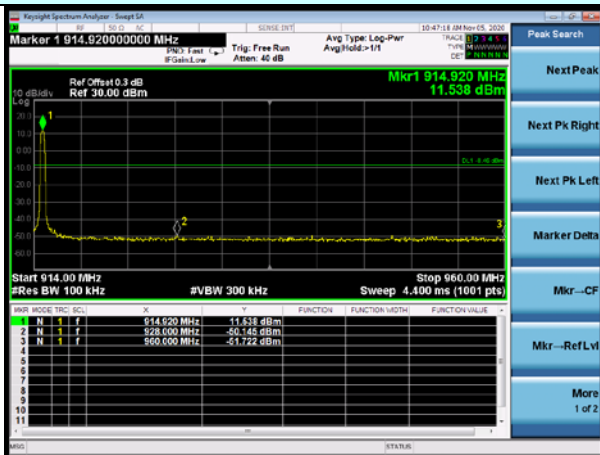

No-hopping mode

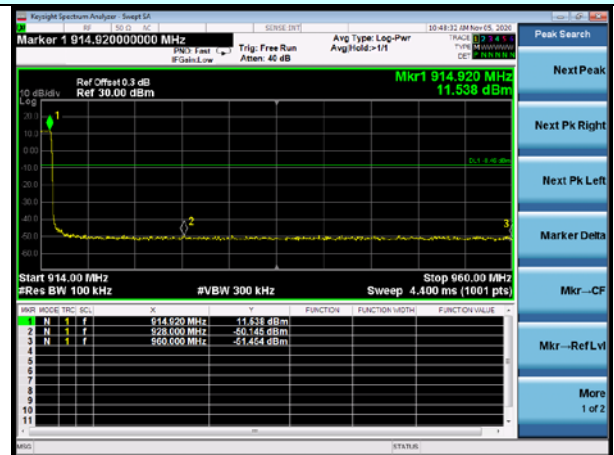

Hopping mode

8.7.2 Radiated Emission Method

Test Requirement:	FCC Part15 C Section 15.209 and 15.205				
Test Method:	ANSI C63.10:2013				
Test Frequency Range:	All of the restrict bands were tested, only the worst band's (2310MHz to 2500MHz) data was showed.				
Test site:	Measurement Distance: 3m				
Receiver setup:	Frequency	Detector	RBW	VBW	Remark
	Above 1GHz	Peak	1MHz	3MHz	Peak Value
Limit:	Frequency	Limit (dBuV/m @3m)		Remark	
	Above 1GHz	54.00		Average Value	
Limit:	Above 1GHz	74.00		Peak Value	
Test setup:					
Test Procedure:	<ol style="list-style-type: none"> 1. The EUT was placed on the top of a rotating table 1.5 meters above the ground at a 3 meter camber. The table was rotated 360 degrees to determine the position of the highest radiation. 2. The EUT was set 3 meters away from the interference-receiving antenna, which was mounted on the top of a variable-height antenna tower. 3. The antenna height is varied from one meter to four meters above the ground to determine the maximum value of the field strength. Both horizontal and vertical polarizations of the antenna are set to make the measurement. 4. For each suspected emission, the EUT was arranged to its worst case and then the antenna was tuned to heights from 1 meter to 4 meters and the rota table was turned from 0 degrees to 360 degrees to find the maximum reading. 5. The test-receiver system was set to Peak Detect Function and Specified Bandwidth with Maximum Hold Mode. 6. If the emission level of the EUT in peak mode was 10dB lower than the limit specified, then testing could be stopped and the peak values of the EUT would be reported. Otherwise the emissions that did not have 10dB margin would be re-tested one by one using peak, quasi-peak or average method as specified and then reported in a data sheet. 				
Test Instruments:	Refer to section 6.0 for details				
Test mode:	Refer to section 5.2 for details				
Test results:	Pass				

Measurement Data

Test channel:	Lowest channel
---------------	----------------

Peak value:

Frequency (MHz)	Read Level (dBuV)	Antenna Factor (dB/m)	Cable Loss (dB)	Preamp Factor (dB)	Level (dBuV/m)	Limit Line (dBuV/m)	Over Limit (dB)	Polarization
902.00	39.30	22.30	4.87	37.60	28.87	74.00	-45.13	Horizontal
902.00	41.37	22.41	4.96	37.57	31.17	74.00	-42.83	Vertical

Average value:

Frequency (MHz)	Read Level (dBuV)	Antenna Factor (dB/m)	Cable Loss (dB)	Preamp Factor (dB)	Level (dBuV/m)	Limit Line (dBuV/m)	Over Limit (dB)	Polarization
902.00	27.33	22.30	4.87	37.60	16.90	54.00	-37.10	Horizontal
902.00	29.18	22.41	4.96	37.57	18.98	54.00	-35.02	Vertical

Test channel:	Highest channel
---------------	-----------------

Peak value:

Frequency (MHz)	Read Level (dBuV)	Antenna Factor (dB/m)	Cable Loss (dB)	Preamp Factor (dB)	Level (dBuV/m)	Limit Line (dBuV/m)	Over Limit (dB)	Polarization
928.00	39.14	22.30	4.87	37.60	28.71	74.00	-45.29	Horizontal
928.00	38.83	22.41	4.96	37.57	28.63	74.00	-45.37	Vertical

Average value:

Frequency (MHz)	Read Level (dBuV)	Antenna Factor (dB/m)	Cable Loss (dB)	Preamp Factor (dB)	Level (dBuV/m)	Limit Line (dBuV/m)	Over Limit (dB)	Polarization
928.00	27.55	22.30	4.87	37.60	17.12	54.00	-36.88	Horizontal
928.00	29.08	22.41	4.96	37.57	18.88	54.00	-35.12	Vertical

Remarks:

1. Final Level = Receiver Read level + Antenna Factor + Cable Loss – Preamplifier Factor
2. The emission levels of other frequencies are very lower than the limit and not show in test report.
3. The pre-test were performed on lowest, middle and highest frequencies, only the worst case's (lowest and highest frequencies) data was showed.

8.8 Spurious Emission

8.8.1 Conducted Emission Method

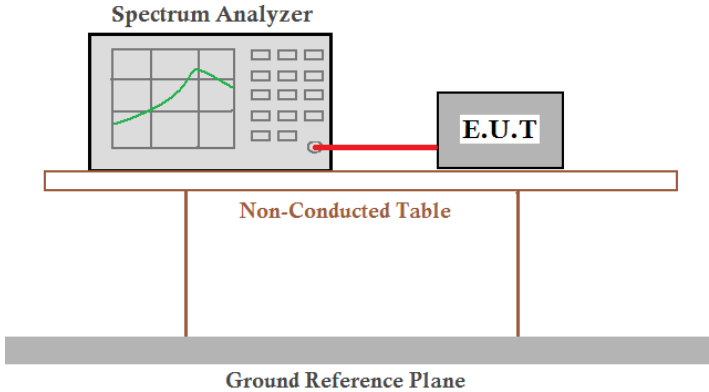
Test Requirement:	FCC Part15 C Section 15.247 (d)
Test Method:	ANSI C63.10:2013
Limit:	In any 100 kHz bandwidth outside the frequency band in which the spread spectrum intentional radiator is operating, the radio frequency power that is produced by the intentional radiator shall be at least 20 dB below that in the 100 kHz bandwidth within the band that contains the highest level of the desired power, based on either an RF conducted or a radiated measurement.
Test setup:	 <p>The diagram illustrates the test setup. A Spectrum Analyzer is connected to an E.U.T. (Equipment Under Test) via a red cable. Both are placed on a Non-Conducted Table, which is supported by two vertical legs. Below the table is a Ground Reference Plane.</p>
Test Instruments:	Refer to section 6.0 for details
Test mode:	Refer to section 5.2 for details
Test results:	Pass

125KHz Bandwidth:

Test channel: Lowest channel

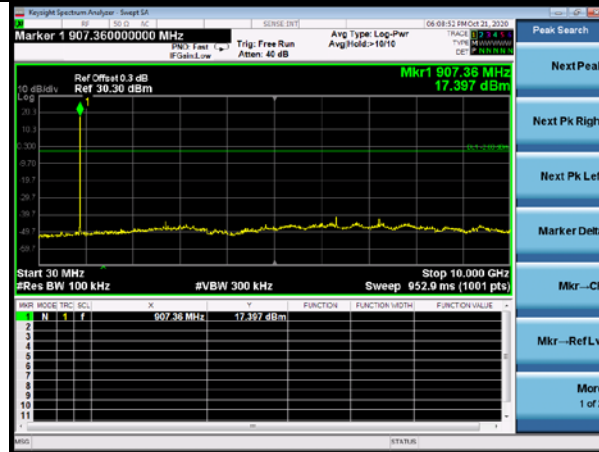

30MHz~10GHz

Test channel: Middle channel

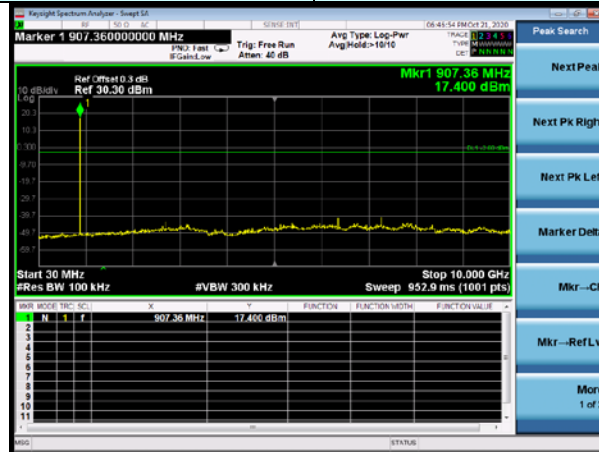

30MHz~10GHz

Test channel: Highest channel

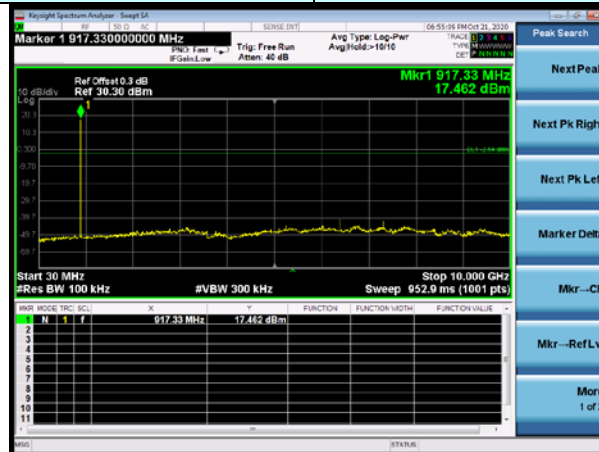

30MHz~10GHz

8.8.2 Radiated Emission Method

Test Requirement:	FCC Part15 C Section 15.209				
Test Method:	ANSI C63.10:2013				
Test Frequency Range:	9kHz to 25GHz				
Test site:	Measurement Distance: 3m				
Receiver setup:	Frequency	Detector	RBW	VBW	Value
	9KHz-150KHz	Quasi-peak	200Hz	600Hz	Quasi-peak
	150KHz-30MHz	Quasi-peak	9KHz	30KHz	Quasi-peak
	30MHz-1GHz	Quasi-peak	120KHz	300KHz	Quasi-peak
	Above 1GHz	Peak	1MHz	3MHz	Peak
Peak		1MHz	10Hz	Average	
Limit:	Frequency	Limit (uV/m)	Value	Measurement Distance	
	0.009MHz-0.490MHz	2400/F(KHz)	QP	300m	
	0.490MHz-1.705MHz	24000/F(KHz)	QP	30m	
	1.705MHz-30MHz	30	QP	30m	
	30MHz-88MHz	100	QP	3m	
	88MHz-216MHz	150	QP		
	216MHz-960MHz	200	QP		
	960MHz-1GHz	500	QP		
	Above 1GHz	500	Average		
		5000	Peak		
Test setup:	For radiated emissions from 9kHz to 30MHz				
	<p>The diagram illustrates the test setup for radiated emissions from 9kHz to 30MHz. It shows an Equipment Under Test (EUT) placed on a turn table. A test antenna is positioned 1m above the ground plane. The distance between the EUT and the antenna is indicated as <math>< 3m ></math>. The turn table diameter is indicated as <math>< 80cm ></math>. A receiver is connected to the test antenna. The ground plane is shown with a ground symbol.</p>				

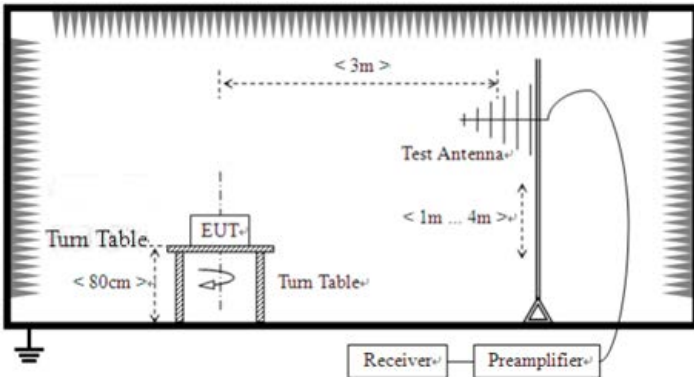
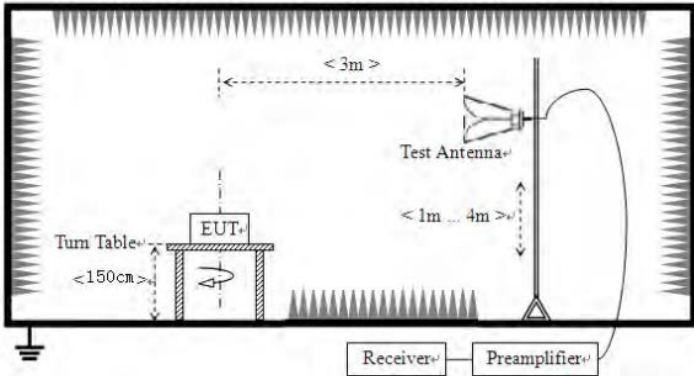
	<p>For radiated emissions from 30MHz to 1GHz</p>  <p>For radiated emissions above 1GHz</p> 
<p>Test Procedure:</p>	<ol style="list-style-type: none"> 1. The EUT was placed on the top of a rotating table (0.8m for below 1G and 1.5m for above 1G) above the ground at a 3 meter camber. The table was rotated 360 degrees to determine the position of the highest radiation. 2. The EUT was set 3 meters away from the interference-receiving antenna, which was mounted on the top of a variable-height antenna tower. 3. The antenna height is varied from one meter to four meters above the ground to determine the maximum value of the field strength. Both horizontal and vertical polarizations of the antenna are set to make the measurement. 4. For each suspected emission, the EUT was arranged to its worst case and then the antenna was tuned to heights from 1 meter to 4 meters and the rota table was turned from 0 degrees to 360 degrees to find the maximum reading. 5. The test-receiver system was set to Peak Detect Function and Specified Bandwidth with Maximum Hold Mode. 6. If the emission level of the EUT in peak mode was 10dB lower than the limit specified, then testing could be stopped and the peak values of the EUT would be reported. Otherwise the emissions that did not have 10dB margin would be re-tested one by one using peak, quasi-peak or average method as specified and then reported in a data sheet.
<p>Test Instruments:</p>	<p>Refer to section 6.0 for details</p>
<p>Test mode:</p>	<p>Refer to section 5.2 for details</p>

Test environment:	Temp.:	25 °C	Humid.:	52%	Press.:	1012mbar
Test voltage:	AC 120V, 60Hz					
Test results:	Pass					

Measurement data:*Remarks:*

1. Pre-scan all kind of the place mode (X-axis, Y-axis, Z-axis), and found the Y-axis which it is worse case.

■ 9kHz~30MHz

The low frequency, which started from 9 kHz to 30 MHz, was pre-scanned and the result which was 20 dB lower than the limit line per 15.31(o) was not reported.

■ Below 1GHz

Horizontal:

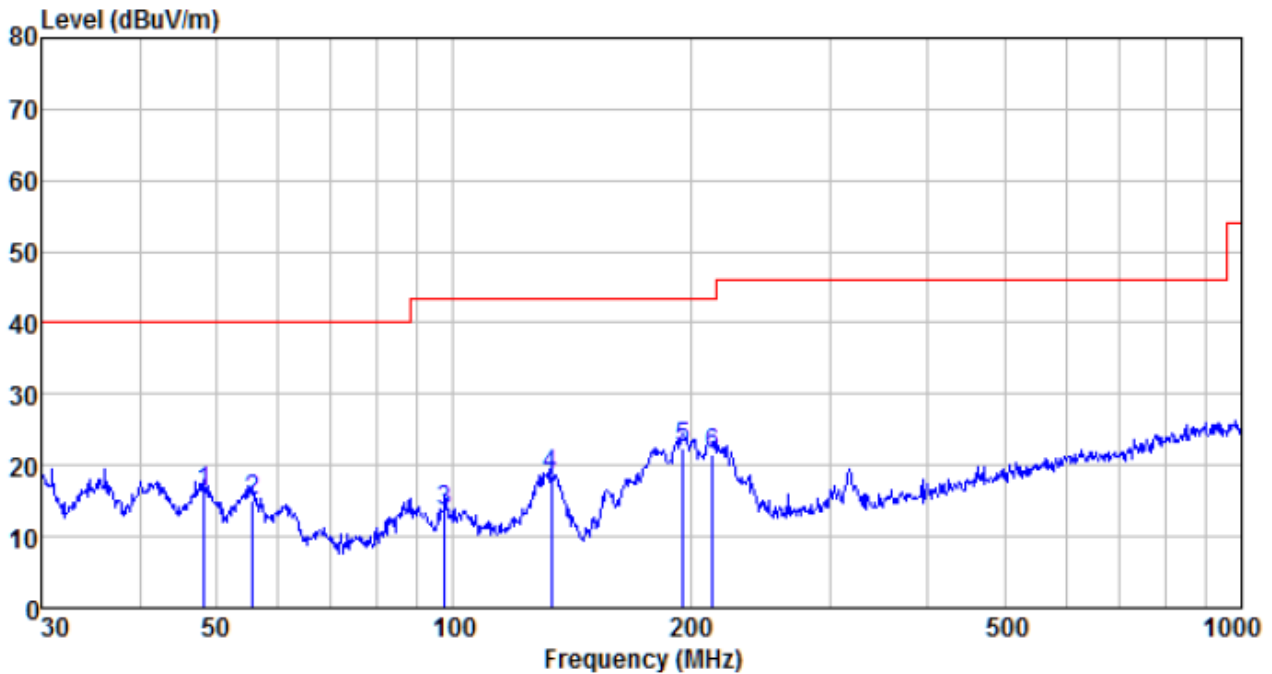

Freq MHz	Reading level dBuV	Antenna factor dB/m	Cable loss dB	Preamp factor dB	level dBuV	Limit level dBuV/m	Over limit dB	Remark
48.332	39.17	12.29	0.75	36.10	16.11	40.00	-23.89	QP
55.609	38.70	11.73	0.82	36.26	14.99	40.00	-25.01	QP
97.456	37.37	11.86	1.17	36.70	13.70	43.50	-29.80	QP
133.151	46.17	7.92	1.46	36.97	18.58	43.50	-24.92	QP
195.822	47.88	10.17	1.82	37.31	22.56	43.50	-20.94	QP
213.015	45.94	10.91	1.92	37.34	21.43	43.50	-22.07	QP

Vertical:

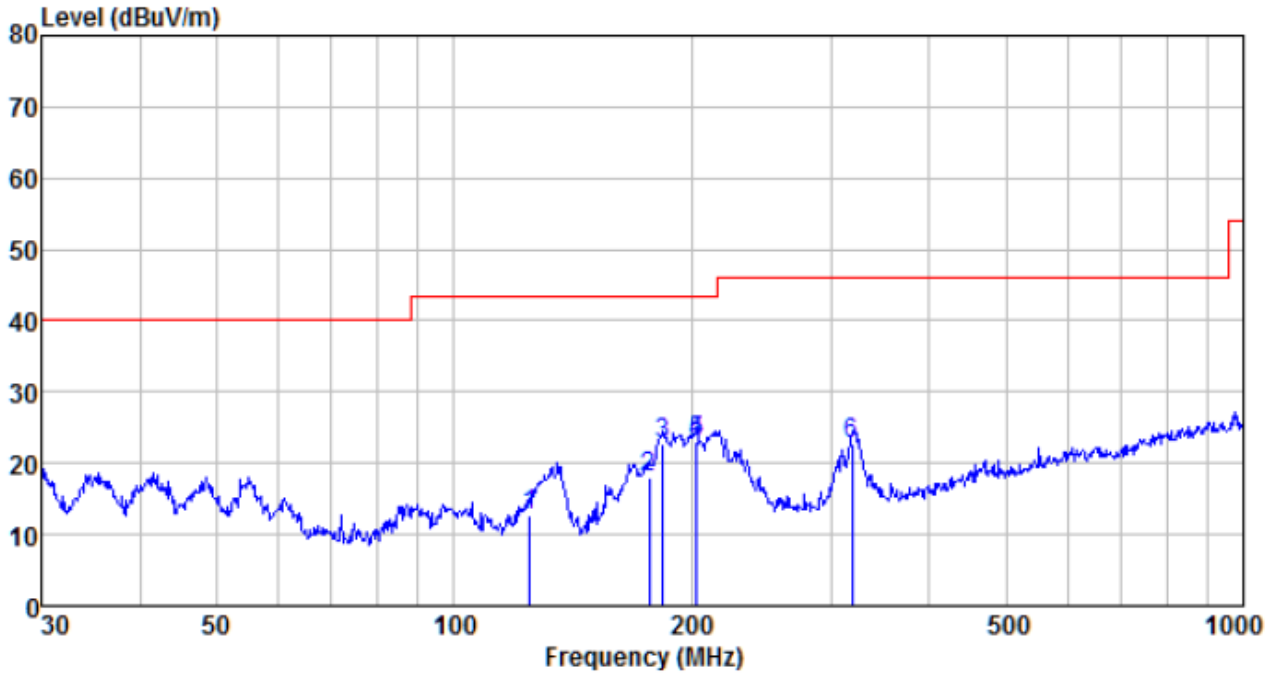

Freq MHz	Reading level dBuV	Antenna factor dB/m	Cable loss dB	Preamp factor dB	level dBuV	Limit level dBuV/m	Over limit dB	Remark
124.569	39.44	8.89	1.40	36.91	12.82	43.50	-30.68	QP
176.888	44.74	8.77	1.72	37.22	18.01	43.50	-25.49	QP
183.844	48.77	9.32	1.76	37.26	22.59	43.50	-20.91	QP
202.810	47.96	10.51	1.86	37.33	23.00	43.50	-20.50	QP
202.810	47.96	10.51	1.86	37.33	23.00	43.50	-20.50	QP
318.817	43.65	13.96	2.46	37.44	22.63	46.00	-23.37	QP

■ Above 1GHz

Test channel:	Lowest channel
---------------	----------------

Peak value:

Frequency (MHz)	Read Level (dBuV)	Antenna Factor (dB/m)	Cable Loss (dB)	Preamp Factor (dB)	Level (dBuV/m)	Limit Line (dBuV/m)	Over Limit (dB)	polarization
1804.60	40.77	25.35	4.67	34.04	36.75	74.00	-37.25	Vertical
2706.90	34.60	28.26	5.43	33.25	35.04	74.00	-38.96	Vertical
3609.20	33.22	29.18	7.11	37.34	32.17	74.00	-41.83	Vertical
4511.50	*					74.00		Vertical
5413.80	*					74.00		Vertical
6316.10	*					74.00		Vertical
1804.60	39.40	25.35	4.67	34.04	35.38	74.00	-38.62	Horizontal
2706.90	34.49	28.26	5.43	33.25	34.93	74.00	-39.07	Horizontal
3609.20	32.50	29.18	7.11	37.34	31.45	74.00	-42.55	Horizontal
4511.50	*					74.00		Horizontal
5413.80	*					74.00		Horizontal
6316.10	*					74.00		Horizontal

Average value:

Frequency (MHz)	Read Level (dBuV)	Antenna Factor (dB/m)	Cable Loss (dB)	Preamp Factor (dB)	Level (dBuV/m)	Limit Line (dBuV/m)	Over Limit (dB)	polarization
1804.60	29.85	25.35	4.67	34.04	25.83	54.00	-28.17	Vertical
2706.90	23.47	28.26	5.43	33.25	23.91	54.00	-30.09	Vertical
3609.20	23.57	29.18	7.11	37.34	22.52	54.00	-31.48	Vertical
4511.50	*					54.00		Vertical
5413.80	*					54.00		Vertical
6316.10	*					54.00		Vertical
1804.60	28.93	25.35	4.67	34.04	24.91	54.00	-29.09	Horizontal
2706.90	23.07	28.26	5.43	33.25	23.51	54.00	-30.49	Horizontal
3609.20	22.25	29.18	7.11	37.34	21.20	54.00	-32.80	Horizontal
4511.50	*					54.00		Horizontal
5413.80	*					54.00		Horizontal
6316.10	*					54.00		Horizontal

Test channel:	Middle channel
---------------	----------------

Peak value:

Frequency (MHz)	Read Level (dBuV)	Antenna Factor (dB/m)	Cable Loss (dB)	Preamp Factor (dB)	Level (dBuV/m)	Limit Line (dBuV/m)	Over Limit (dB)	polarization
1817.00	39.81	25.43	4.89	34.12	36.01	74.00	-37.99	Vertical
2725.50	34.66	28.34	5.68	33.57	35.11	74.00	-38.89	Vertical
3634.00	34.24	29.42	7.29	37.66	33.29	74.00	-40.71	Vertical
4542.50	*					74.00		Vertical
5451.00	*					74.00		Vertical
6359.50	*					74.00		Vertical
1817.00	40.25	25.43	4.89	34.12	36.45	74.00	-37.55	Horizontal
2725.50	33.45	28.34	5.68	33.57	33.90	74.00	-40.10	Horizontal
3634.00	33.82	29.42	7.29	37.66	32.87	74.00	-41.13	Horizontal
4542.50	*					74.00		Horizontal
5451.00	*					74.00		Horizontal
6359.50	*					74.00		Horizontal

Average value:

Frequency (MHz)	Read Level (dBuV)	Antenna Factor (dB/m)	Cable Loss (dB)	Preamp Factor (dB)	Level (dBuV/m)	Limit Line (dBuV/m)	Over Limit (dB)	polarization
1817.00	30.66	25.43	4.89	34.12	26.86	54.00	-27.14	Vertical
2725.50	22.98	28.34	5.68	33.57	23.43	54.00	-30.57	Vertical
3634.00	23.49	29.42	7.29	37.66	22.54	54.00	-31.46	Vertical
4542.50	*					54.00		Vertical
5451.00	*					54.00		Vertical
6359.50	*					54.00		Vertical
1817.00	30.36	25.43	4.89	34.12	26.56	54.00	-27.44	Horizontal
2725.50	22.54	28.34	5.68	33.57	22.99	54.00	-31.01	Horizontal
3634.00	23.54	29.42	7.29	37.66	22.59	54.00	-31.41	Horizontal
4542.50	*					54.00		Horizontal
5451.00	*					54.00		Horizontal
6359.50	*					54.00		Horizontal

Test channel:	Highest channel
---------------	-----------------

Peak value:

Frequency (MHz)	Read Level (dBuV)	Antenna Factor (dB/m)	Cable Loss (dB)	Preamp Factor (dB)	Level (dBuV/m)	Limit Line (dBuV/m)	Over Limit (dB)	polarization
1829.80	45.38	25.64	4.75	34.67	41.10	74.00	-32.90	Vertical
2744.70	35.36	28.46	5.87	33.83	35.86	74.00	-38.14	Vertical
3659.60	37.55	29.75	7.59	37.76	37.13	74.00	-36.87	Vertical
4574.50	*					74.00		Vertical
5489.40	*					74.00		Vertical
6404.30	*					74.00		Vertical
1829.80	44.64	25.64	4.75	34.67	40.36	74.00	-33.64	Horizontal
2744.70	34.41	28.46	5.87	33.83	34.91	74.00	-39.09	Horizontal
3659.60	33.42	29.75	7.59	37.76	33.00	74.00	-41.00	Horizontal
4574.50	*					74.00		Horizontal
5489.40	*					74.00		Horizontal
6404.30	*					74.00		Horizontal

Average value:

Frequency (MHz)	Read Level (dBuV)	Antenna Factor (dB/m)	Cable Loss (dB)	Preamp Factor (dB)	Level (dBuV/m)	Limit Line (dBuV/m)	Over Limit (dB)	polarization
1829.80	36.29	25.64	4.75	34.67	32.01	54.00	-21.99	Vertical
2744.70	25.28	28.46	5.87	33.83	25.78	54.00	-28.22	Vertical
3659.60	26.05	29.75	7.59	37.76	25.63	54.00	-28.37	Vertical
4574.50	*					54.00		Vertical
5489.40	*					54.00		Vertical
6404.30	*					54.00		Vertical
1829.80	35.00	25.64	4.75	34.67	30.72	54.00	-23.28	Horizontal
2744.70	23.79	28.46	5.87	33.83	24.29	54.00	-29.71	Horizontal
3659.60	22.68	29.75	7.59	37.76	22.26	54.00	-31.74	Horizontal
4574.50	*					54.00		Horizontal
5489.40	*					54.00		Horizontal
6404.30	*					54.00		Horizontal

Remarks:

1. Final Level = Receiver Read level + Antenna Factor + Cable Loss – Pre-amplifier Factor
2. “*” means this data is too weak instrument of signal is unable to test.
3. The emission levels of other frequencies are very lower than the limit and not show in test report.
4. The test data shows only the worst case 125KHz bandwidth mode.

9 Test Items for DTS

9.1 Conducted Peak Output Power

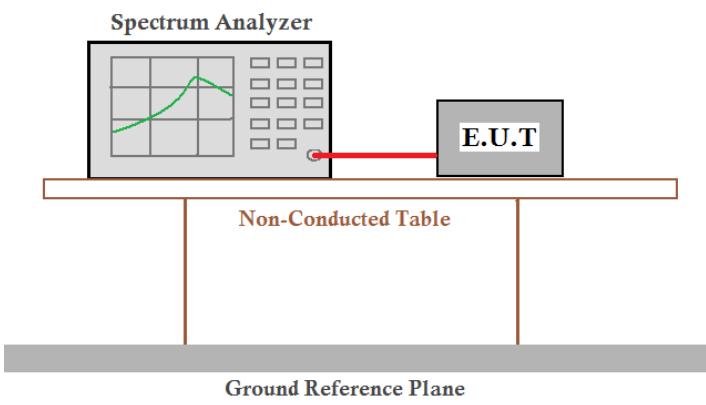
Test Requirement:	FCC Part15 C Section 15.247 (b)(3)
Test Method:	ANSI C63.10:2013 and KDB558074 D01 DTS Meas Guidance v05r02
Limit:	30dBm
Test setup:	 <p>The diagram illustrates the test setup. A Spectrum Analyzer is connected to an E.U.T. (Equipment Under Test) via a red cable. Both are placed on a Non-Conducted Table, which is supported by a Ground Reference Plane.</p>
Test Instruments:	Refer to section 6.0 for details
Test mode:	Refer to section 5.2 for details
Test results:	Pass

Measurement Data

500KHz Bandwidth:

Test channel	Peak Output Power (dBm)	Limit(dBm)	Result
Lowest	14.039	30.00	Pass
Middle	12.134		
Highest	11.528		

Test plot as follows:

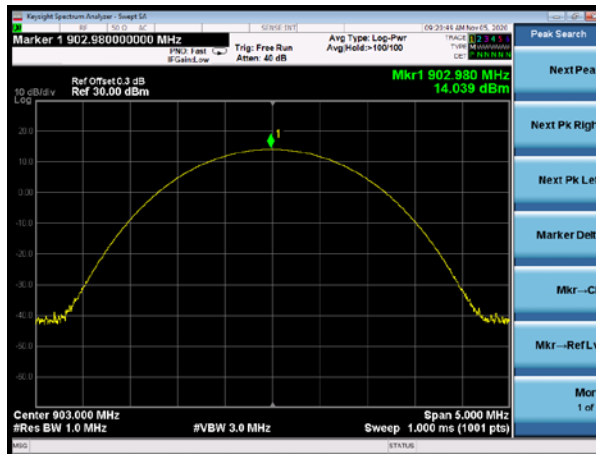

Lowest channel

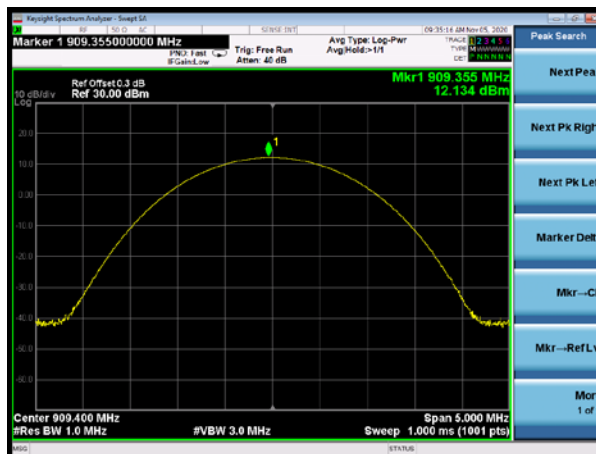

Middle channel

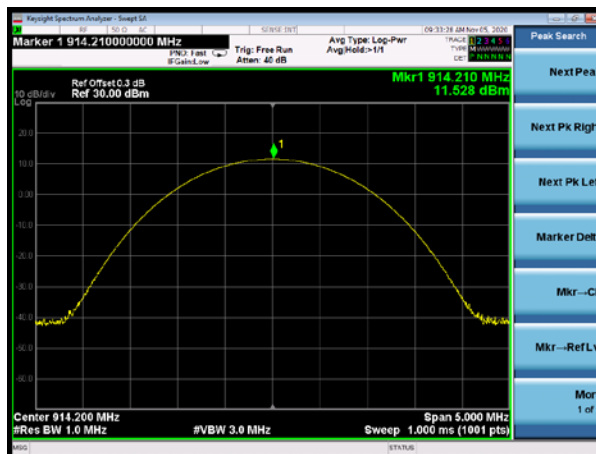

Highest channel

9.2 Channel Bandwidth

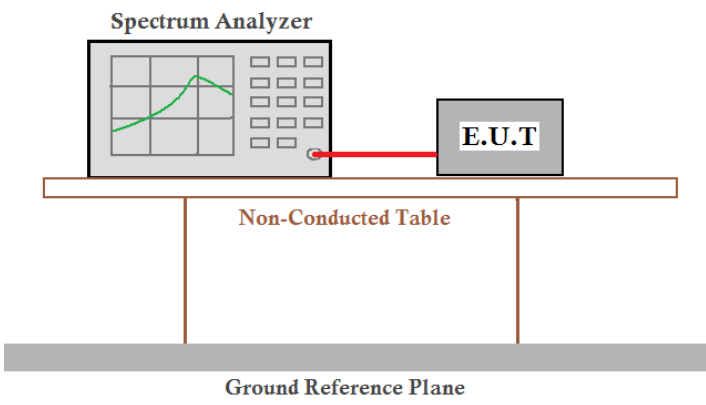
Test Requirement:	FCC Part15 C Section 15.247 (a)(2)
Test Method:	ANSI C63.10:2013 and KDB558074 D01 DTS Meas Guidance v05r02
Limit:	>500KHz
Test setup:	 <p>The diagram illustrates the test setup. A Spectrum Analyzer is connected to an E.U.T. (Equipment Under Test) via a red cable. Both are placed on a Non-Conducted Table, which is supported by a Ground Reference Plane.</p>
Test Instruments:	Refer to section 6.0 for details
Test mode:	Refer to section 5.2 for details
Test results:	Pass

Measurement Data

500KHz Bandwidth:

Test channel	Channel Bandwidth (KHz)	Limit(KHz)	Result
Lowest	590.5	>500	Pass
Middle	589.6		
Highest	584.5		

Test plot as follows:

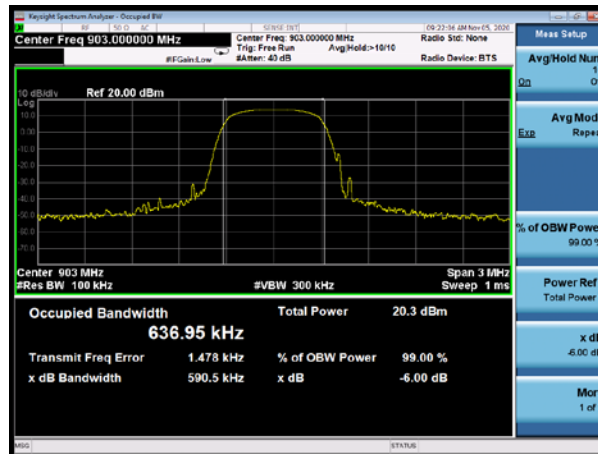

Lowest channel



Middle channel



Highest channel

9.3 Power Spectral Density

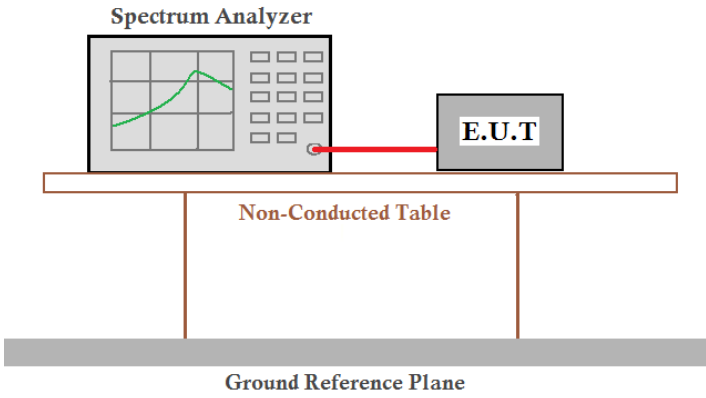
Test Requirement:	FCC Part15 C Section 15.247 (e)
Test Method:	ANSI C63.10:2013 and KDB558074 D01 DTS Meas Guidance v05r02
Limit:	8dBm/3kHz
Test setup:	 <p>The diagram illustrates the test setup. A Spectrum Analyzer is connected to an E.U.T. (Equipment Under Test) via a red cable. Both are placed on a Non-Conducted Table, which is supported by a Ground Reference Plane.</p>
Test Instruments:	Refer to section 6.0 for details
Test mode:	Refer to section 5.2 for details
Test results:	Pass

Measurement Data

Test channel	Power Spectral Density (dBm/3kHz)	Limit(dBm/3kHz)	Result
Lowest	5.085	8.00	Pass
Middle	3.155		
Highest	2.305		

Test plot as follows:

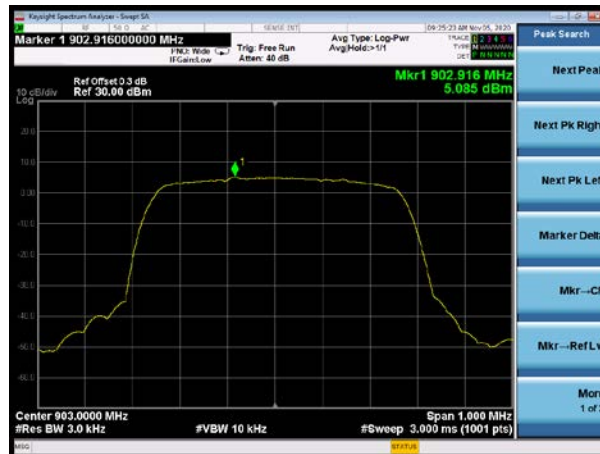

Lowest channel

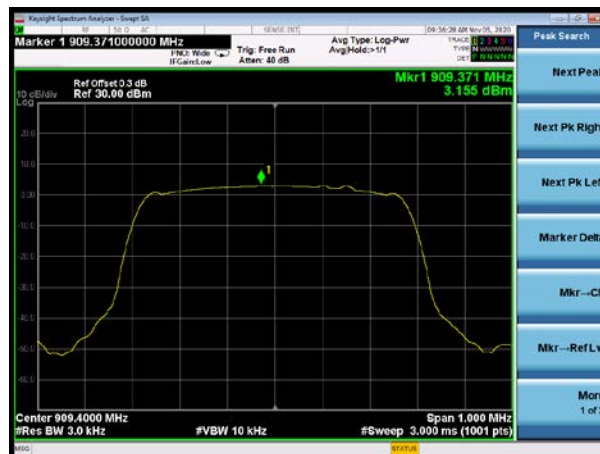

Middle channel

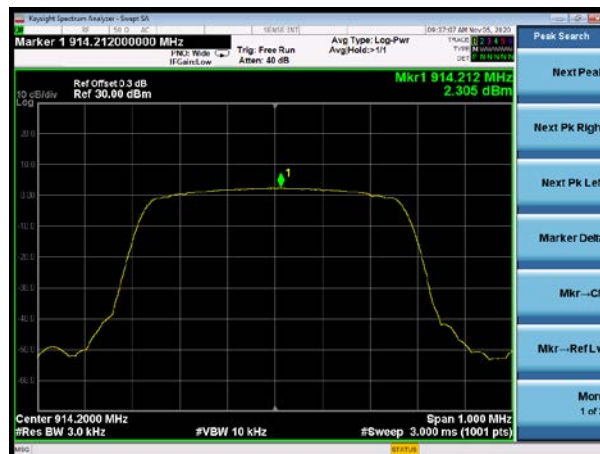

Highest channel

9.4 Band edges

9.4.1 Conducted Emission Method

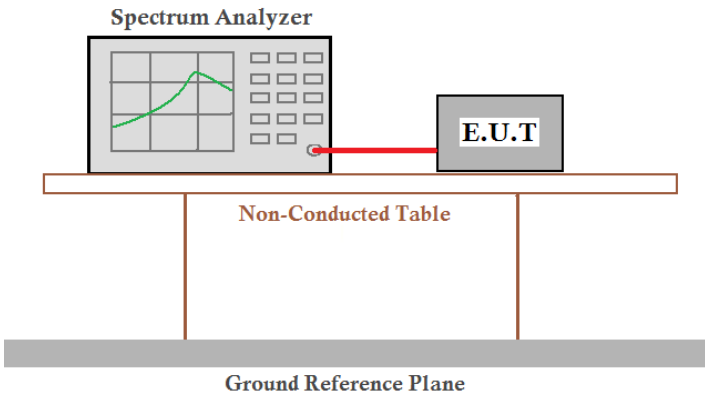
Test Requirement:	FCC Part15 C Section 15.247 (d)
Test Method:	ANSI C63.10:2013 and KDB558074 D01 DTS Meas Guidance v05r02
Limit:	In any 100 kHz bandwidth outside the frequency band in which the spread spectrum intentional radiator is operating, the radio frequency power that is produced by the intentional radiator shall be at least 20 dB below that in the 100 kHz bandwidth within the band that contains the highest level of the desired power, based on either an RF conducted or a radiated measurement.
Test setup:	
Test Instruments:	Refer to section 6.0 for details
Test mode:	Refer to section 5.2 for details
Test results:	Pass

Test plot as follows:

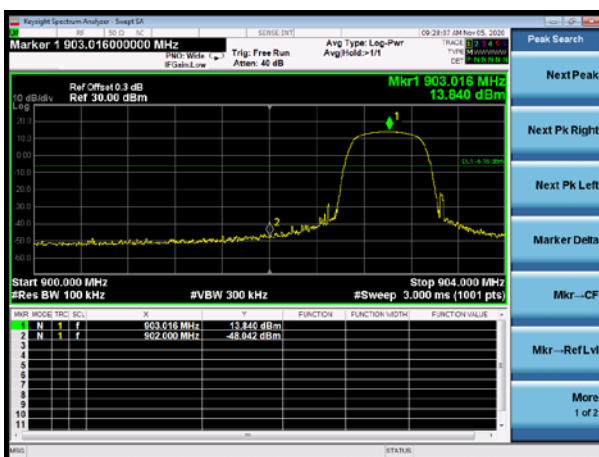

Lowest Channel

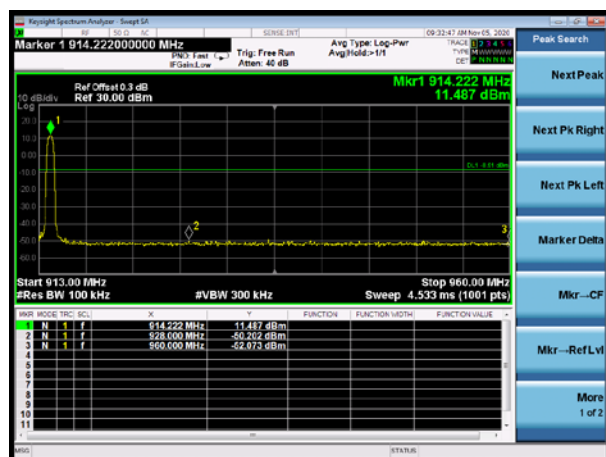

Highest Channel

9.4.2 Radiated Emission Method

Test Requirement:	FCC Part15 C Section 15.209 and 15.205				
Test Method:	ANSI C63.10:2013				
Test Frequency Range:	All of the restrict bands were tested, only the worst band's (2310MHz to 2500MHz) data was showed.				
Test site:	Measurement Distance: 3m				
Receiver setup:	Frequency	Detector	RBW	VBW	Value
	Above 1GHz	Peak	1MHz	3MHz	Peak
RMS		1MHz	3MHz	Average	
Limit:	Frequency	Limit (dBuV/m @3m)		Value	
	Above 1GHz	54.00		Average	
		74.00		Peak	
Test setup:					
Test Procedure:	<ol style="list-style-type: none"> 1. The EUT was placed on the top of a rotating table 1.5 meters above the ground at a 3 meter camber. The table was rotated 360 degrees to determine the position of the highest radiation. 2. The EUT was set 3 meters away from the interference-receiving antenna, which was mounted on the top of a variable-height antenna tower. 3. The antenna height is varied from one meter to four meters above the ground to determine the maximum value of the field strength. Both horizontal and vertical polarizations of the antenna are set to make the measurement. 4. For each suspected emission, the EUT was arranged to its worst case and then the antenna was tuned to heights from 1 meter to 4 meters and the rota table was turned from 0 degrees to 360 degrees to find the maximum reading. 5. The test-receiver system was set to Peak Detect Function and Specified Bandwidth with Maximum Hold Mode. 6. If the emission level of the EUT in peak mode was 10dB lower than the limit specified, then testing could be stopped and the peak values of the EUT would be reported. Otherwise the emissions that did not have 10dB margin would be re-tested one by one using peak, quasi-peak or average method as specified and then reported in a data sheet. 				

	7. The radiation measurements are performed in X, Y, Z axis positioning. And found the X axis positioning which it is worse case, only the test worst case mode is recorded in the report.
Test Instruments:	Refer to section 6.0 for details
Test mode:	Refer to section 5.2 for details
Test results:	Pass

Measurement Data

Test channel:	Lowest channel
---------------	----------------

Peak value:

Frequency (MHz)	Read Level (dBuV)	Antenna Factor (dB/m)	Cable Loss (dB)	Preamp Factor (dB)	Level (dBuV/m)	Limit Line (dBuV/m)	Over Limit (dB)	Polarization
902.00	39.55	22.30	4.87	37.60	29.12	74.00	-44.88	Horizontal
902.00	41.53	22.41	4.96	37.57	31.33	74.00	-42.67	Vertical

Average value:

Frequency (MHz)	Read Level (dBuV)	Antenna Factor (dB/m)	Cable Loss (dB)	Preamp Factor (dB)	Level (dBuV/m)	Limit Line (dBuV/m)	Over Limit (dB)	Polarization
902.00	27.69	22.30	4.87	37.60	17.26	54.00	-36.74	Horizontal
902.00	29.36	22.41	4.96	37.57	19.16	54.00	-34.84	Vertical

Test channel:	Highest channel
---------------	-----------------

Peak value:

Frequency (MHz)	Read Level (dBuV)	Antenna Factor (dB/m)	Cable Loss (dB)	Preamp Factor (dB)	Level (dBuV/m)	Limit Line (dBuV/m)	Over Limit (dB)	Polarization
928.00	39.17	22.30	4.87	37.60	28.74	74.00	-45.26	Horizontal
928.00	38.85	22.41	4.96	37.57	28.65	74.00	-45.35	Vertical

Average value:

Frequency (MHz)	Read Level (dBuV)	Antenna Factor (dB/m)	Cable Loss (dB)	Preamp Factor (dB)	Level (dBuV/m)	Limit Line (dBuV/m)	Over Limit (dB)	Polarization
928.00	27.58	22.30	4.87	37.60	17.15	54.00	-36.85	Horizontal
928.00	29.11	22.41	4.96	37.57	18.91	54.00	-35.09	Vertical

Remarks:

1. Final Level = Receiver Read level + Antenna Factor + Cable Loss – Preamplifier Factor
2. The emission levels of other frequencies are very lower than the limit and not show in test report.
3. The pre-test were performed on lowest, middle and highest frequencies, only the worst case's (lowest and highest frequencies) data was showed.

9.5 Spurious Emission

9.5.1 Conducted Emission Method

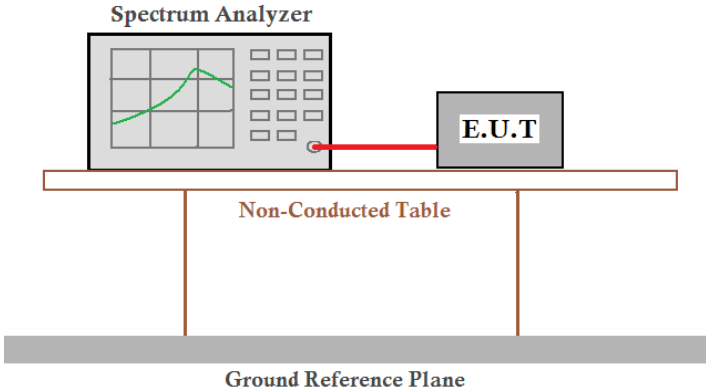
Test Requirement:	FCC Part15 C Section 15.247 (d)
Test Method:	ANSI C63.10:2013 and KDB558074 D01 DTS Meas Guidance v05r02
Limit:	In any 100 kHz bandwidth outside the frequency band in which the spread spectrum intentional radiator is operating, the radio frequency power that is produced by the intentional radiator shall be at least 20 dB below that in the 100 kHz bandwidth within the band that contains the highest level of the desired power, based on either an RF conducted or a radiated measurement.
Test setup:	 <p>The diagram illustrates the test setup. A Spectrum Analyzer is connected to an E.U.T. (Equipment Under Test) via a red cable. Both the Spectrum Analyzer and the E.U.T. are placed on a Non-Conducted Table. The table is supported by a Ground Reference Plane.</p>
Test Instruments:	Refer to section 6.0 for details
Test mode:	Refer to section 5.2 for details
Test results:	Pass

Test plot as follows:

Test channel: Lowest channel

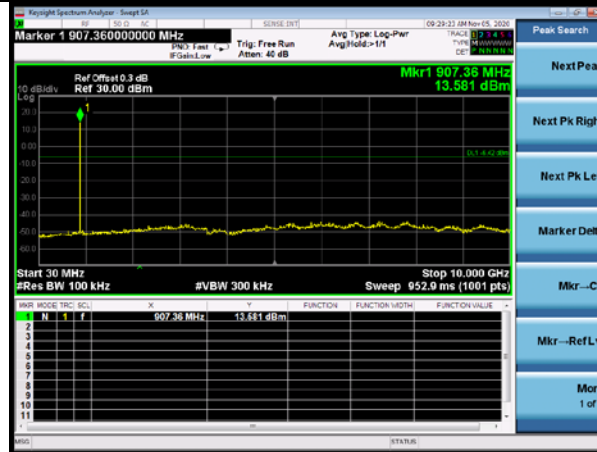

30MHz~10GHz

Test channel: Middle channel

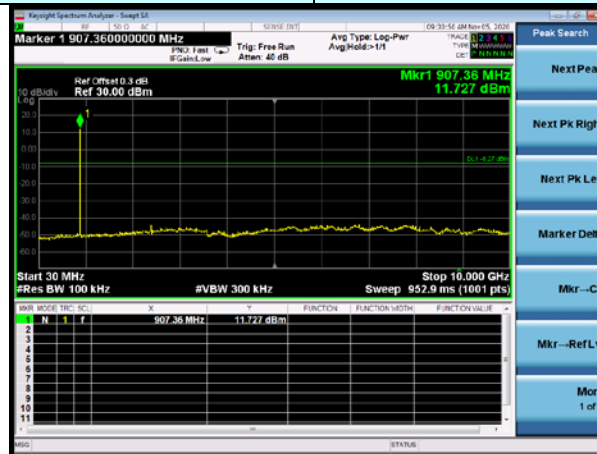

30MHz~10GHz

Test channel: Highest channel

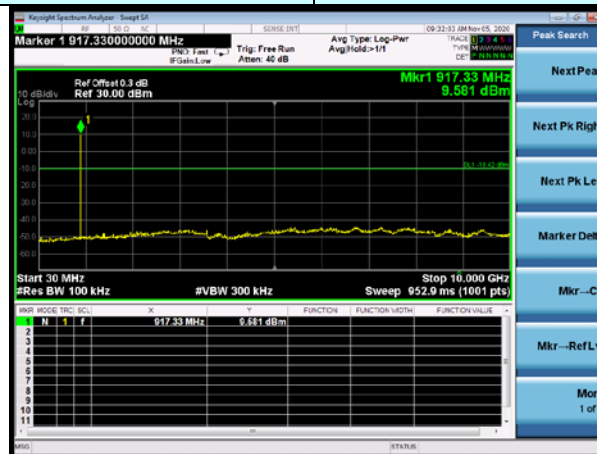

30MHz~10GHz

9.5.2 Radiated Emission Method

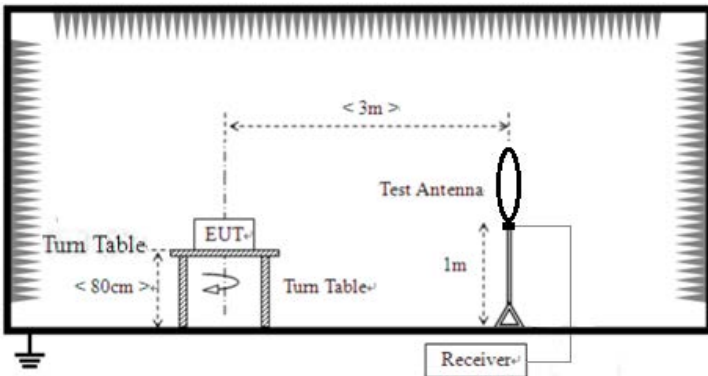
Test Requirement:	FCC Part15 C Section 15.209				
Test Method:	ANSI C63.10:2013				
Test Frequency Range:	9kHz to 25GHz				
Test site:	Measurement Distance: 3m				
Receiver setup:	Frequency	Detector	RBW	VBW	Value
	9KHz-150KHz	Quasi-peak	200Hz	600Hz	Quasi-peak
	150KHz-30MHz	Quasi-peak	9KHz	30KHz	Quasi-peak
	30MHz-1GHz	Quasi-peak	120KHz	300KHz	Quasi-peak
	Above 1GHz	Peak	1MHz	3MHz	Peak
Peak		1MHz	10Hz	Average	
Limit:	Frequency	Limit (uV/m)	Value	Measurement Distance	
	0.009MHz-0.490MHz	2400/F(KHz)	QP	300m	
	0.490MHz-1.705MHz	24000/F(KHz)	QP	30m	
	1.705MHz-30MHz	30	QP	30m	
	30MHz-88MHz	100	QP	3m	
	88MHz-216MHz	150	QP		
	216MHz-960MHz	200	QP		
	960MHz-1GHz	500	QP		
	Above 1GHz	500	Average		
		5000	Peak		
Test setup:	<p>For radiated emissions from 9kHz to 30MHz</p> 				

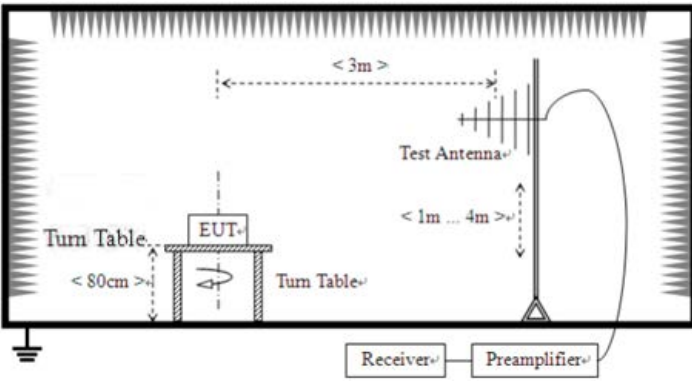
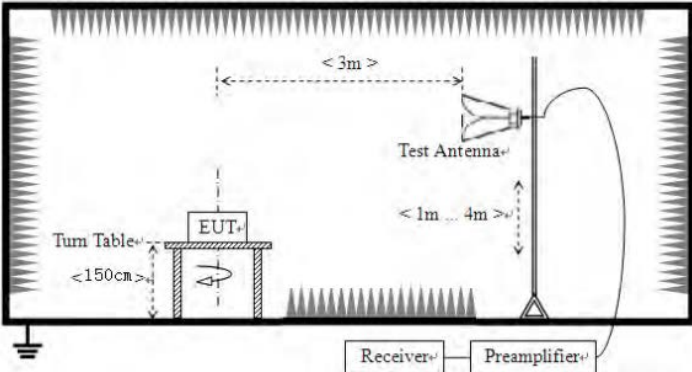
	<p>For radiated emissions from 30MHz to 1GHz</p>  <p>For radiated emissions above 1GHz</p> 
<p>Test Procedure:</p>	<ol style="list-style-type: none"> 1. The EUT was placed on the top of a rotating table (0.8m for below 1G and 1.5m for above 1G) above the ground at a 3 meter camber. The table was rotated 360 degrees to determine the position of the highest radiation. 2. The EUT was set 3 meters away from the interference-receiving antenna, which was mounted on the top of a variable-height antenna tower. 3. The antenna height is varied from one meter to four meters above the ground to determine the maximum value of the field strength. Both horizontal and vertical polarizations of the antenna are set to make the measurement. 4. For each suspected emission, the EUT was arranged to its worst case and then the antenna was tuned to heights from 1 meter to 4 meters and the rota table was turned from 0 degrees to 360 degrees to find the maximum reading. 5. The test-receiver system was set to Peak Detect Function and Specified Bandwidth with Maximum Hold Mode. 6. If the emission level of the EUT in peak mode was 10dB lower than the limit specified, then testing could be stopped and the peak values of the EUT would be reported. Otherwise the emissions that did not have 10dB margin would be re-tested one by one using peak, quasi-peak or average method as specified and then reported in a data sheet.

Test Instruments:	Refer to section 6.0 for details					
Test mode:	Refer to section 5.2 for details					
Test environment:	Temp.:	25 °C	Humid.:	52%	Press.:	1012mbar
Test voltage:	AC 120V, 60Hz					
Test results:	Pass					

Measurement data:*Remark:*

Pre-scan all kind of the place mode (X-axis, Y-axis, Z-axis), and found the Y-axis which it is worse case.

■ 9kHz~30MHz

The low frequency, which started from 9 kHz to 30 MHz, was pre-scanned and the result which was 20 dB lower than the limit line per 15.31(o) was not reported.

■ Below 1GHz

Horizontal:

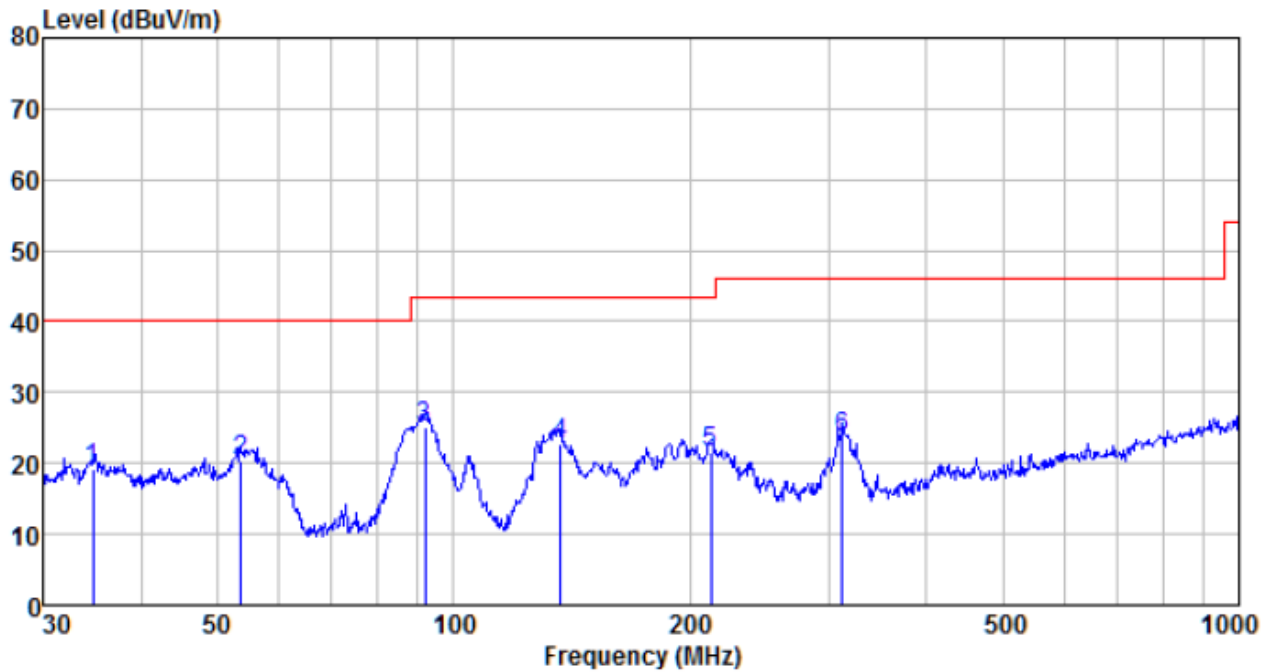

Freq MHz	Reading level dBuV	Antenna factor dB/m	Cable loss dB	Preamp factor dB	level dBuV	Limit level dBuV/m	Over limit dB	Remark
34.760	42.62	11.30	0.61	35.34	19.19	40.00	-20.81	QP
53.693	44.00	11.93	0.81	36.24	20.50	40.00	-19.50	QP
91.816	49.79	10.97	1.12	36.65	25.23	43.50	-18.27	QP
136.939	50.63	7.64	1.48	37.00	22.75	43.50	-20.75	QP
212.270	45.99	10.87	1.91	37.34	21.43	43.50	-22.07	QP
312.179	44.83	13.85	2.42	37.43	23.67	46.00	-22.33	QP

Vertical:

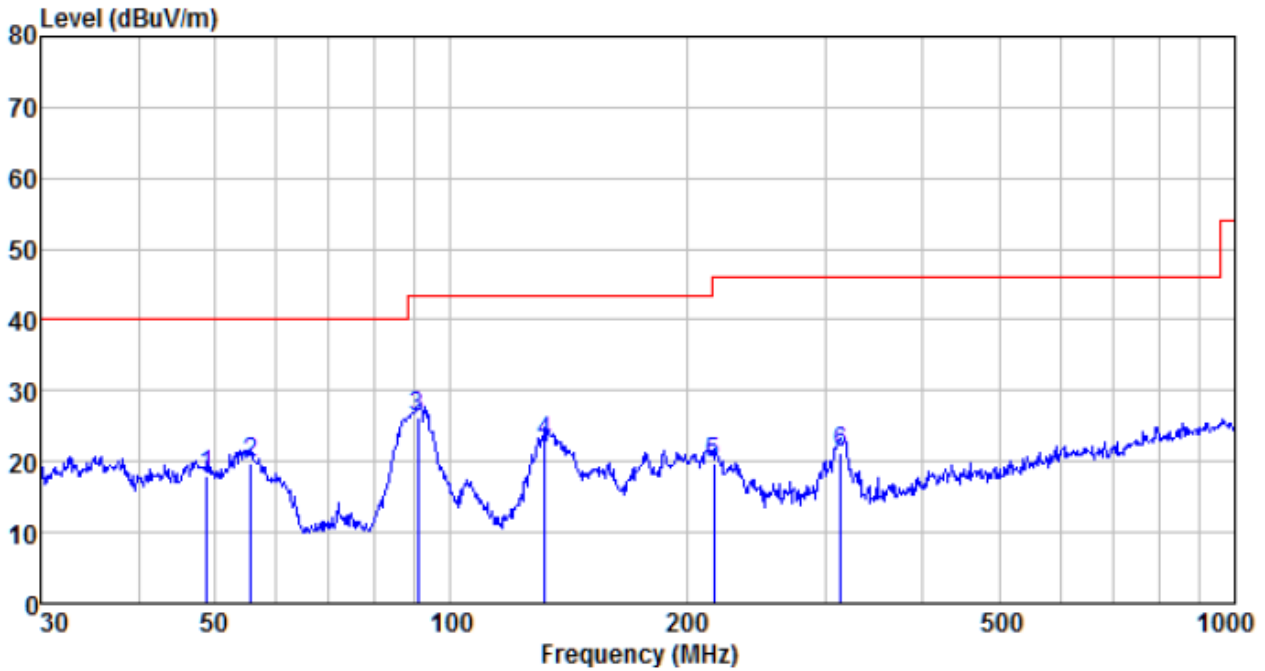

Freq MHz	Reading level dBuV	Antenna factor dB/m	Cable loss dB	Preamp factor dB	level dBuV	Limit level dBuV/m	Over limit dB	Remark
48.843	41.09	12.29	0.76	36.13	18.01	40.00	-21.99	QP
55.609	43.51	11.73	0.82	36.26	19.80	40.00	-20.20	QP
90.855	50.82	10.84	1.12	36.65	26.13	43.50	-17.37	QP
131.758	50.28	8.06	1.45	36.96	22.83	43.50	-20.67	QP
216.783	44.22	11.02	1.94	37.35	19.83	46.00	-26.17	QP
314.377	42.43	13.87	2.44	37.44	21.30	46.00	-24.70	QP

■ Above 1GHz

Test channel:	Lowest channel
---------------	----------------

Peak value:

Frequency (MHz)	Read Level (dBuV)	Antenna Factor (dB/m)	Cable Loss (dB)	Preamp Factor (dB)	Level (dBuV/m)	Limit Line (dBuV/m)	Over Limit (dB)	polarization
1806.00	41.35	25.25	4.85	34.08	37.37	74.00	-36.63	Vertical
2709.00	35.00	28.12	5.66	33.68	35.10	74.00	-38.90	Vertical
3612.00	33.64	29.19	7.25	37.37	32.71	74.00	-41.29	Vertical
4515.00	*					74.00		Vertical
5418.00	*					74.00		Vertical
6321.00	*					74.00		Vertical
1806.00	39.90	25.25	4.85	34.08	35.92	74.00	-38.08	Horizontal
2709.00	34.95	28.12	5.66	33.68	35.05	74.00	-38.95	Horizontal
3612.00	32.74	29.19	7.25	37.37	31.81	74.00	-42.19	Horizontal
4515.00	*					74.00		Horizontal
5418.00	*					74.00		Horizontal
6321.00	*					74.00		Horizontal

Average value:

Frequency (MHz)	Read Level (dBuV)	Antenna Factor (dB/m)	Cable Loss (dB)	Preamp Factor (dB)	Level (dBuV/m)	Limit Line (dBuV/m)	Over Limit (dB)	polarization
1806.00	30.40	25.25	4.85	34.08	26.42	54.00	-27.58	Vertical
2709.00	23.86	28.12	5.66	33.68	23.96	54.00	-30.04	Vertical
3612.00	23.98	29.19	7.25	37.37	23.05	54.00	-30.95	Vertical
4515.00	*					54.00		Vertical
5418.00	*					54.00		Vertical
6321.00	*					54.00		Vertical
1806.00	29.41	25.25	4.85	34.08	25.43	54.00	-28.57	Horizontal
2709.00	23.52	28.12	5.66	33.68	23.62	54.00	-30.38	Horizontal
3612.00	22.48	29.19	7.25	37.37	21.55	54.00	-32.45	Horizontal
4515.00	*					54.00		Horizontal
5418.00	*					54.00		Horizontal
6321.00	*					54.00		Horizontal

Remarks:

1. Final Level = Receiver Read level + Antenna Factor + Cable Loss – Pre-amplifier Factor
2. The emission levels of other frequencies are very lower than the limit and not show in test report.
3. “*”, means this data is the too weak instrument of signal is unable to test.

Test channel:	Middle
---------------	--------

Peak value:

Frequency (MHz)	Read Level (dBuV)	Antenna Factor (dB/m)	Cable Loss (dB)	Preamp Factor (dB)	Level (dBuV/m)	Limit Line (dBuV/m)	Over Limit (dB)	polarization
1818.80	40.18	25.43	4.89	34.12	36.38	74.00	-37.62	Vertical
2728.20	34.91	28.34	5.68	33.57	35.36	74.00	-38.64	Vertical
3637.60	34.45	29.42	7.29	37.66	33.50	74.00	-40.50	Vertical
4547.00	*					74.00		Vertical
5456.40	*					74.00		Vertical
6365.80	*					74.00		Vertical
1818.80	40.56	25.43	4.89	34.12	36.76	74.00	-37.24	Horizontal
2728.20	33.70	28.34	5.68	33.57	34.15	74.00	-39.85	Horizontal
3637.60	33.97	29.42	7.29	37.66	33.02	74.00	-40.98	Horizontal
4547.00	*					74.00		Horizontal
5456.40	*					74.00		Horizontal
6365.80	*					74.00		Horizontal

Average value:

Frequency (MHz)	Read Level (dBuV)	Antenna Factor (dB/m)	Cable Loss (dB)	Preamp Factor (dB)	Level (dBuV/m)	Limit Line (dBuV/m)	Over Limit (dB)	polarization
1818.80	31.00	25.43	4.89	34.12	27.20	54.00	-26.80	Vertical
2728.20	23.21	28.34	5.68	33.57	23.66	54.00	-30.34	Vertical
3637.60	23.70	29.42	7.29	37.66	22.75	54.00	-31.25	Vertical
4547.00	*					54.00		Vertical
5456.40	*					54.00		Vertical
6365.80	*					54.00		Vertical
1818.80	30.66	25.43	4.89	34.12	26.86	54.00	-27.14	Horizontal
2728.20	22.78	28.34	5.68	33.57	23.23	54.00	-30.77	Horizontal
3637.60	23.68	29.42	7.29	37.66	22.73	54.00	-31.27	Horizontal
4547.00	*					54.00		Horizontal
5456.40	*					54.00		Horizontal
6365.80	*					54.00		Horizontal

Remarks:

1. *Final Level = Receiver Read level + Antenna Factor + Cable Loss – Pre-amplifier Factor*
2. *The emission levels of other frequencies are very lower than the limit and not show in test report.*
3. *“*”*, means this data is the too weak instrument of signal is unable to test.

Test channel:	Highest
---------------	---------

Peak value:

Frequency (MHz)	Read Level (dBuV)	Antenna Factor (dB/m)	Cable Loss (dB)	Preamp Factor (dB)	Level (dBuV/m)	Limit Line (dBuV/m)	Over Limit (dB)	polarization
1828.40	45.97	25.56	4.89	34.23	42.19	74.00	-31.81	Vertical
2742.60	35.75	28.23	5.7	33.63	36.05	74.00	-37.95	Vertical
3656.80	37.87	29.25	7.34	37.37	37.09	74.00	-36.91	Vertical
4571.00	*					74.00		Vertical
5485.20	*					74.00		Vertical
6399.40	*					74.00		Vertical
1828.40	45.14	25.56	4.89	34.23	41.36	74.00	-32.64	Horizontal
2742.60	34.78	28.23	5.7	33.63	35.08	74.00	-38.92	Horizontal
3656.80	33.66	29.25	7.34	37.37	32.88	74.00	-41.12	Horizontal
4571.00	*					74.00		Horizontal
5485.20	*					74.00		Horizontal
6399.40	*					74.00		Horizontal

Average value:

Frequency (MHz)	Read Level (dBuV)	Antenna Factor (dB/m)	Cable Loss (dB)	Preamp Factor (dB)	Level (dBuV/m)	Limit Line (dBuV/m)	Over Limit (dB)	polarization
1828.40	36.83	25.56	4.89	34.23	33.05	54.00	-20.95	Vertical
2742.60	25.65	28.23	5.7	33.63	25.95	54.00	-28.05	Vertical
3656.80	26.36	29.25	7.34	37.37	25.58	54.00	-28.42	Vertical
4571.00	*					54.00		Vertical
5485.20	*					54.00		Vertical
6399.40	*					54.00		Vertical
1828.40	35.47	25.56	4.89	34.23	31.69	54.00	-22.31	Horizontal
2742.60	24.16	28.23	5.7	33.63	24.46	54.00	-29.54	Horizontal
3656.80	22.91	29.25	7.34	37.37	22.13	54.00	-31.87	Horizontal
4571.00	*					54.00		Horizontal
5485.20	*					54.00		Horizontal
6399.40	*					54.00		Horizontal

Remarks:

1. Final Level = Receiver Read level + Antenna Factor + Cable Loss – Pre-amplifier Factor
2. “*”, means this data is too weak instrument of signal is unable to test.
3. The emission levels of other frequencies are very lower than the limit and not show in test report.

10 Test Setup Photo

Reference to the **appendix I** for details.

11 EUT Constructional Details

Reference to the **appendix II** for details.

-----End-----